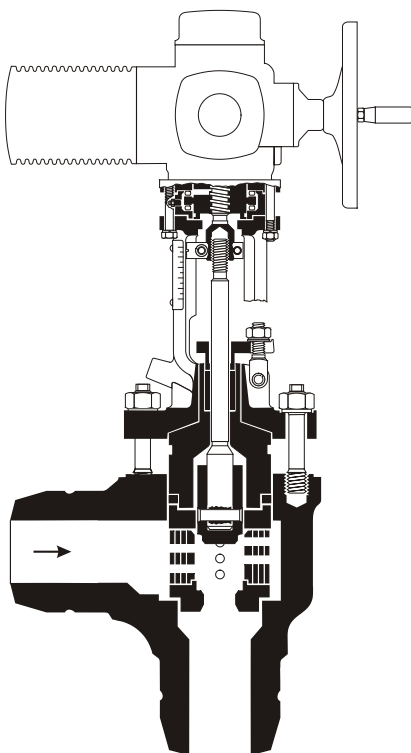

 ZK 210/02, DN 50 (2")
with butt-weld ends

 ZK 210/14, DN 80 (3")
with butt-weld ends

Control Valve with Radial Stage Nozzle

ZK 210 PN 250 DN 25, 50, 80 (1", 2", 3")

Description

Control valve for operation at high differential pressures.

Application, for example, in industrial plants and power stations as

- Injection-cooling valve
- Warm-up valve
- Drain valve
- Continuous blowdown valve
- Feedwater control valve
- Leak-off valve
- Steam control valve

The pressure drop is decreased in the radial stage nozzle in several stages, so that the flow velocity is reduced leading to a considerable reduction in wear and noise.

Straight-through valve (DN 25, 50 (1", 2")) or angle valve (DN 80 (3")) with yoke, spindle with plug and radial stage nozzle.

Internals (incl. seat) completely exchangeable. Leak rate A according EN12266-1

Pressure / Temperature Rating

PMA (Maximum allowable pressure)	[barg] [psig]	250 3625	217 3145	54 785
TMA (Maximum allowable temperature)	[°C] [°F]	300 572	450 842	550 1022
ΔPMX (Maximum differential pressure)	[barg] [psig]	3 stages: 100 bar (1450 psi) 4/5 stages: 180 bar (2610 psi)		

Differential pressure = **inlet** pressure minus **outlet** pressure

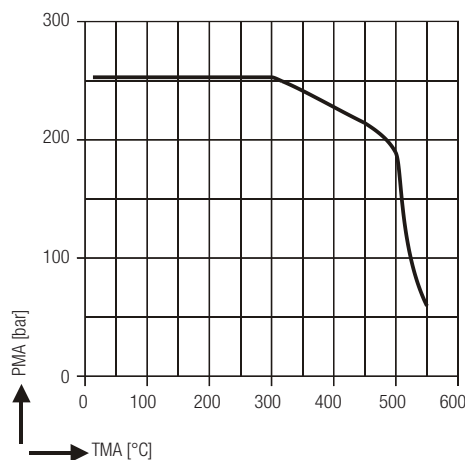

Materials	
Body	forged alloy steel 13 CrMo 4 4 (1.7335*)
Valve seat	3 stages: X90 CrMoV 18 (1.4112) 4/5 stages: X39CrMo17-1 (1.4122)
Valve spindle and plug	X39CrMo17-1 (1.4122)

*) On request, at extra cost butt-weld ends of other materials and dimensions by welding of pipe ends.

The following actuators can be fitted to the valve:

1. ZK 210/02
Manual operation, convertible for electric rotary actuators
2. ZK 210/13
Electric linear actuator
3. ZK 210/14 (**standard**)
Design with insert bush F10-B1 for fitting an electric rotary actuator or a handwheel.
4. ZK 210/20
Pneumatic diaphragm actuator

Connections

Butt-weld ends (**standard**)

Special end connections on request.

Dimensions

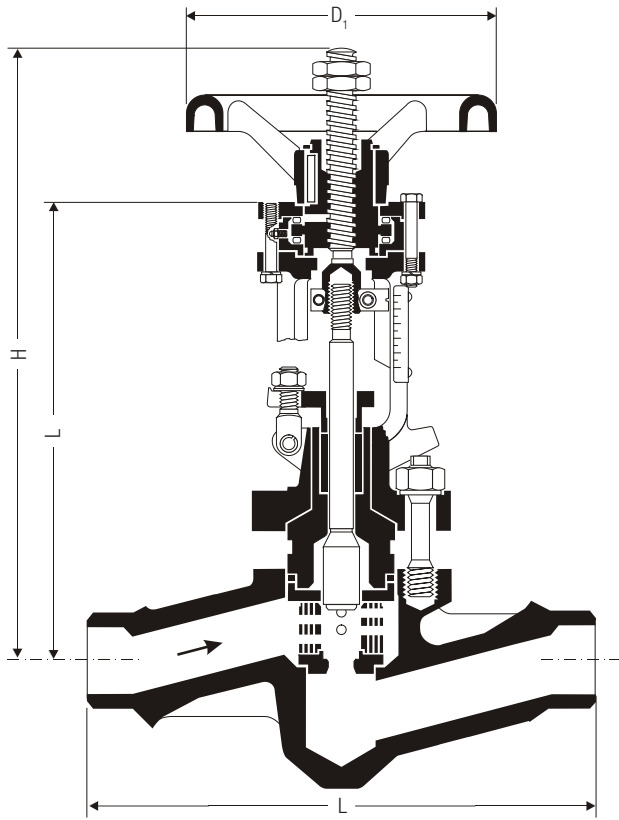

ZK 210/02 with handwheel
DN 25, 50 (1", 2")

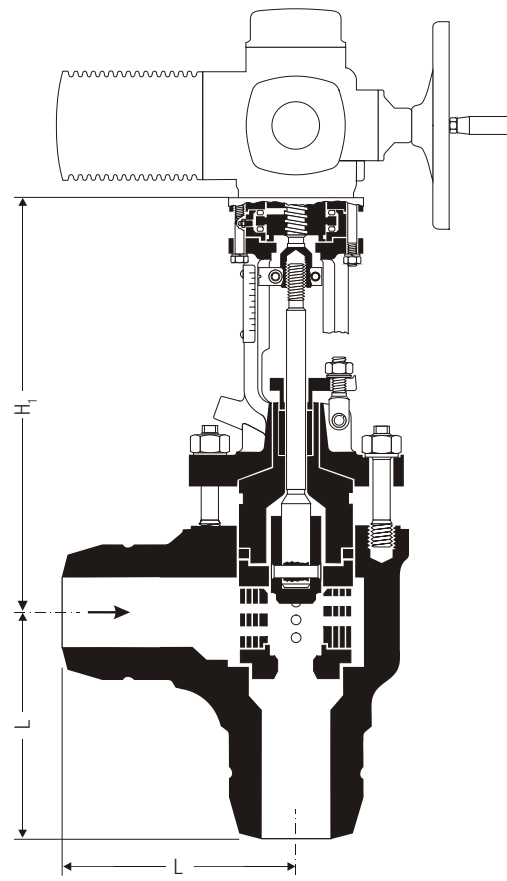

ZK 210/14,
DN 80 (3")
with electric rotary actuator

DN	[mm]	25	50	80
	[in]	1	2	3
Dimensions in mm	L	230	300	225
	H	384	455	535
	H ₁	287	345	375
	D ₁	200	200	320
Butt-weld ends for pipe		33.7x3.6	60.3x6.3	114.3x11
Approx. weight for design ZK 210/14	[kg]	12	25	60
	handwheel [kg]	1.6	1.6	6

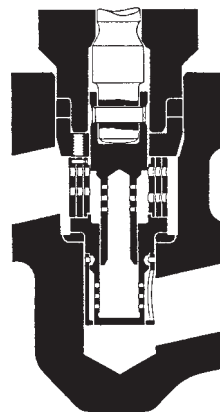

ZK 210, DN 50 (2")
5 stages

k_{vs} values Selection of Actuator

DN	Nozzle*)	Characteristic	K_{vs}			Valve stroke [mm]	Rev./stroke	Max. admiss. torque for opening/closing [Nm]	Type/size of actuator DIN ISO 5210
			[m³/h]						
25 (1")	3 stages	linear	0.8	1.5	2.3	18	3.6	20/25	B1-F10
25 (1")	3 stages	equal-percentage	0.8	1.5	2.3	18	3.6	20/25	B1-F10
25 (1")	4 stages	linear	0.5			13	2.6	20/25	B1-F10
50 (2")	3 stages	linear	3.3	6.5	10	35	7	30/60	B1-F10
50 (2")	3 stages	equal-percentage	3	6	9	35	7	30/60	B1-F10
50 (2")	5 stages	linear	2			23	4.6	30/60	B1-F10
80 (3")	3 stages	linear	9.5	18	28	50	10	80/120	B1-F10
80 (3")	3 stages	equal-percentage	8.5	18	25	50	10	80/120	B1-F10
80 (3")	5 stages	linear	5			35	7	80/120	B1-F10

*) 3 stages: $\Delta p_{max} = 100$ bar (1450 psi) (standard) 4/5 stages: $\Delta p_{max} = 180$ bar (2610 psi)

Example of Application

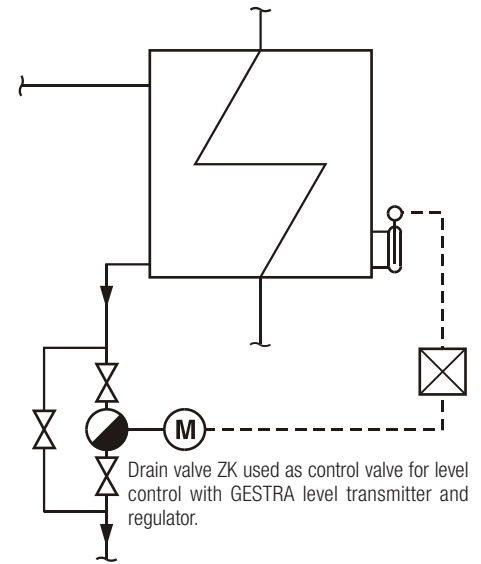

Calculation of Required k_v value*)

- For water flowrates within temperature ranges where flashing because of pressure drop is not to be expected (e.g. leak-off and injection-cooling valves) the calculated k_v value has to be multiplied by a correction factor taken from the chart below due to the successive expansion. The chart includes a safety factor of 1.2.
- If, due to the pressure drop, flashing is to be expected, the formulae below should not be used to calculate the k_v value. In this case see overleaf for hot water capacity charts. If $p_2/p_1 > 0.5$ multiply the chart reading by the correction factor K taken from the backpressure chart below. The safety factor of 1.2 must always be taken into consideration.
- For steam the calculated k_v value has to be multiplied by a safety factor of 1.2.

Pressure drop	k_v	for liquids	for gas, temperature-corrected	for vapours	for saturated and wet steam
$\Delta p < \frac{p_1}{2}$ $(p_2 > \frac{p_1}{2})$	k_v	$= \frac{\dot{V}}{31.6} \sqrt{\frac{\rho_1}{\Delta p}} = \frac{\dot{m}}{31.6 \sqrt{\rho_1 \cdot \Delta p}}$	$= \frac{\dot{V}_N}{514} \sqrt{\frac{\rho_N \cdot T_1}{\Delta p \cdot p_2}}$	$= \frac{\dot{m}}{31.6} \sqrt{\frac{v}{\Delta p}}$	$= \frac{\dot{m}}{31.6} \sqrt{\frac{v \cdot x}{\Delta p}}$
$\Delta p > \frac{p_1}{2}$ $(p_2 < \frac{p_1}{2})$	k_v		$= \frac{2 \dot{V}_N}{514 \cdot p_1} \sqrt{\rho_N \cdot T_1}$	$= \frac{\dot{m}}{31.6} \sqrt{\frac{2v}{p_1}}$	$= \frac{\dot{m}}{31.6} \sqrt{\frac{v \cdot x \cdot 2}{p_1}}$

*) Conversion Factors:
 C_v (U.S.) = $1.16 \cdot k_v$
 C_v (U.K.) = $0.98 \cdot k_v$

Nomenclature:

k_v	Valve flow coefficient for fully open valve within control range	[m³/h]
\dot{V}	Flowrate	[m³/h]
\dot{m}	Flowrate	[kg/h]
\dot{V}_N	Volume flowrate for gases at standard state (0°C, 1013 mbar)	[m³/h]
p_1	Upstream pressure	[bar a]
p_2	Downstream pressure	[bar a]
Δp	Pressure drop $p_1 - p_2$	[bar]
ρ_1	Density of fluid with operating condition at T_1 and p_2	[kg/m³]
ρ_N	Density of gases at standard state (0°C, 1013 mbar)	[kg/m³]
v	Specific steam volume at T_1 and p_2 or – if $\Delta p > \frac{p_1}{2}$ – at $\frac{p_1}{2}$	[m³/kg]
T_1	Absolute inlet temperature of fluid	[K]
x	Content of dry saturated steam in wet steam (0 < x ≤ 1)	

Correction factor for water flowrates (without flashing)

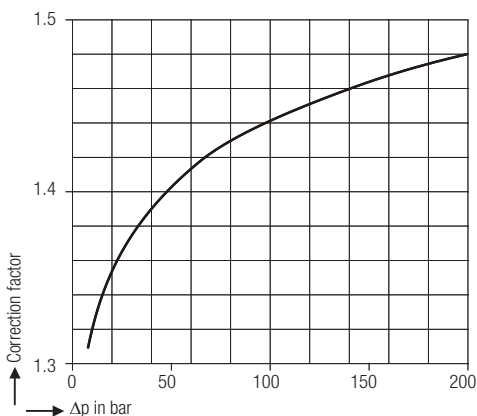

Backpressure chart

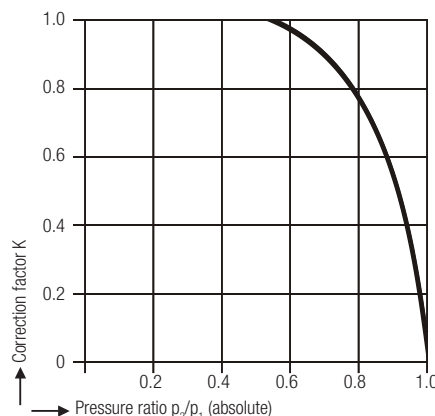

Control Valve with Radial Stage Nozzle

ZK 210

PN 250

DN 25, 50, 80 (1", 2", 3")

Capacity Charts

The charts indicate the maximum capacities of hot and cold water (condensate) the valve can discharge in continuous operation with the spindle in the utmost control position and linear characteristic.

Within their control range the valves (in all sizes) have a linear characteristic. For special operating conditions the adjustment of the radial stage nozzle can be modified to obtain different K_{vs} values and consequently flowrates varying from those indicated in the charts opposite. The linear characteristic is, however, maintained.

It is also possible to change the lift-flowrate characteristic from linear to equal-percentage by repositioning nozzle rings.

Order and Enquiry Specifications

GESTRA Control valve with radial stage nozzle ZK 210

Design data: $p = \dots$ barg, $t = \dots$ °C or PN

Operation: load conditions (1 to 3)

	1	2	3
p_1 [bara]			
t_1 [°C]			
p_2 [bara]			
M [kg/h]			

Please enter data.

Fluid:

Actuation: Electric (make)

ON / OFF or MODULATING CONTROL

Voltage/Hz /

Pneumatic.....(make)

Spring to open:

Spring to close:

Handwheel:

Positioner:

Inspection & Certification

Documentation regarding material tests and in-house examination with inspection certificate to EN 10204-3.1 or EN 10204-3.2 available at extra cost.

Please state the inspection and certification requirements when inquiring or ordering. After supply of the equipment certification cannot be established.

Charges and extent of the above mentioned certificates as well as the different tests confirmed therein are listed in our price list "Test and Inspection Charges for Standard Equipment".

For other test certificates please consult us.

Supply in accordance with our general terms of business.

Cold water

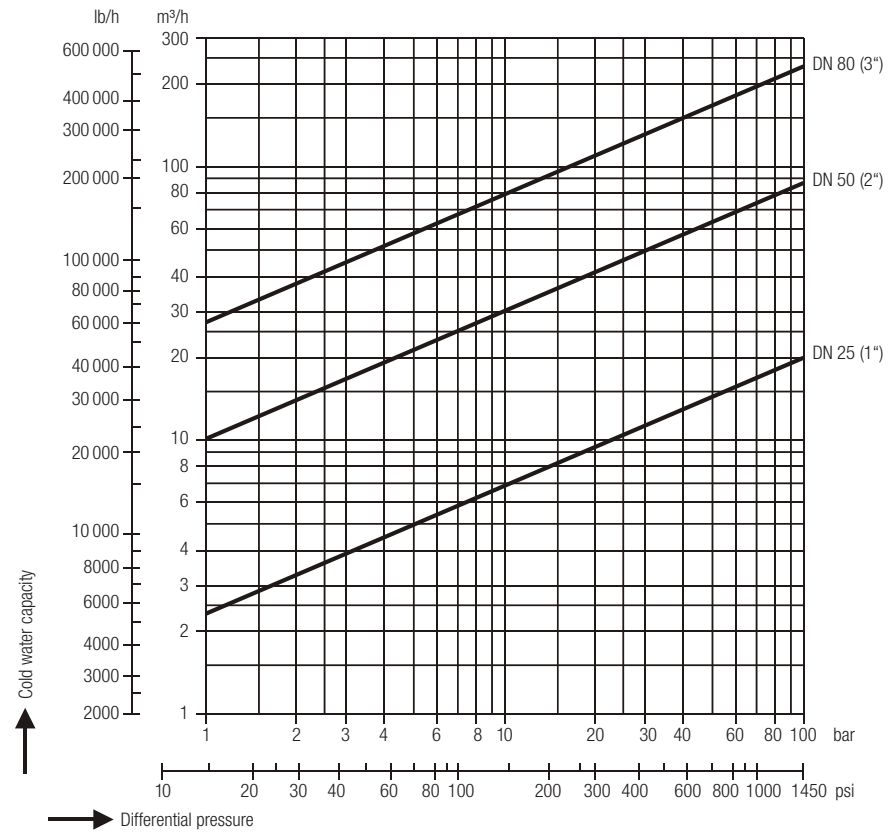

Hot water

$t_s - 5 K$

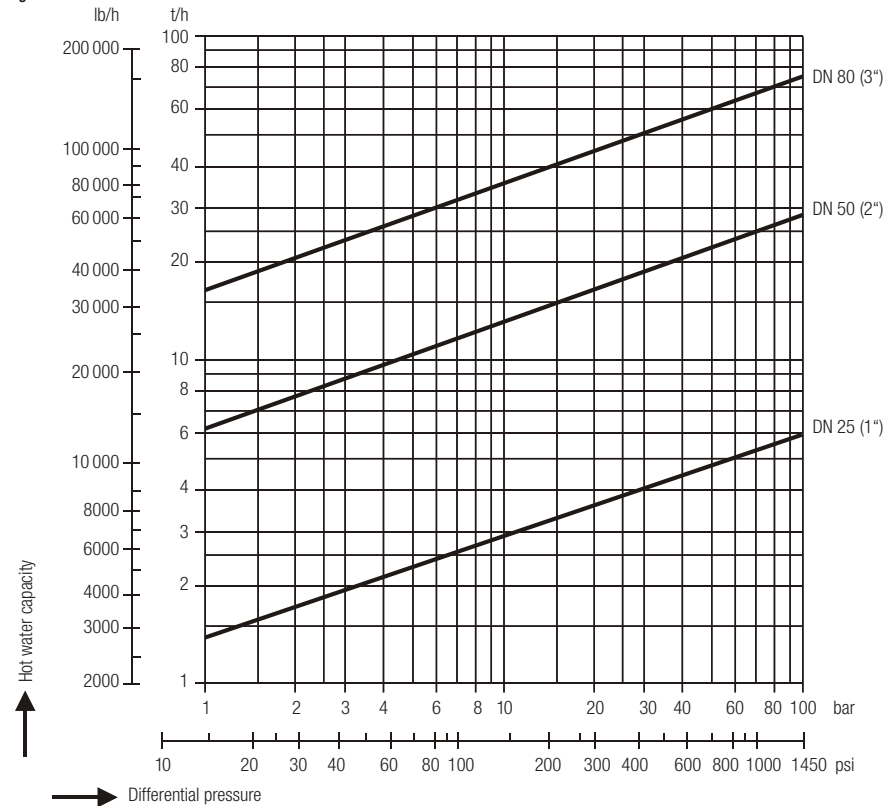

GESTRA AG

Münchener Straße 77, 28215 Bremen, Germany
 Telefon +49 421 3503-0, Telefax +49 421 3503-393
 E-mail info@de.gestra.com, Web www.gestra.de

