

Conductivity Controller LRR  
Visual Display and Operating Unit URB

**LRR 1-52**

**LRR 1-53**

**URB 55**

# Contents

<b>Content of this Manual</b> .....	<b>5</b>
<b>Scope of delivery/Product package</b> .....	<b>5</b>
<b>How to use this Manual</b> .....	<b>6</b>
<b>Illustrations and symbols used</b> .....	<b>6</b>
<b>Hazard symbols in this Manual</b> .....	<b>6</b>
<b>Types of warning</b> .....	<b>7</b>
<b>Specialist terms/Abbreviations</b> .....	<b>8</b>
<b>Usage for the intended purpose</b> .....	<b>10</b>
IT security and rules for the use of Ethernet devices .....	11
<b>Improper use</b> .....	<b>11</b>
<b>Basic safety notes</b> .....	<b>12</b>
<b>Required personnel qualifications</b> .....	<b>12</b>
<b>Notes on product liability</b> .....	<b>12</b>
<b>Function</b> .....	<b>13</b>
Possible combinations of functions and equipment .....	13
<b>Technical data - LRR 1-52, LRR 1-53</b> .....	<b>15</b>
<b>Technical data - URB 55</b> .....	<b>17</b>
<b>Factory settings - LRR 1-52, LRR 1-53</b> .....	<b>19</b>
LRR 1-52.....	19
LRR 1-53.....	19
LRR 1-52, LRR 1-53 .....	19
<b>Factory settings - URB 55</b> .....	<b>20</b>
<b>Example name plate / Marking - LRR 1-52, LRR 1-53</b> .....	<b>21</b>
<b>Example name plate / Marking - URB 55</b> .....	<b>22</b>
<b>Functional elements and dimensions - LRR 1-52, LRR 1-53</b> .....	<b>23</b>
<b>Installing the LRR 1-52, LRR 1-53 conductivity controller</b> .....	<b>24</b>
<b>Dimensions - URB 55</b> .....	<b>25</b>
Required installation aperture in the control cabinet door or switch panel .....	25
<b>Installing the URB 55</b> .....	<b>26</b>
<b>Connecting the URB 55</b> .....	<b>27</b>
Ports and sockets on the back of the unit.....	27
Connection for 24 V DC supply voltage - pin assignment.....	27
Pin assignment of the data line between the URB 55 and the LRR 1-52, LRR 1-53.....	27
<b>Safety notes for electrical connection</b> .....	<b>28</b>

# Contents

<b>Wiring diagram - LRR 1-52 conductivity controller</b> .....	<b>29</b>
Connecting LRG 1x-xx conductivity electrodes .....	29
Connecting an LRG 16-9 conductivity electrode .....	30
<b>Wiring diagram - LRR 1-53 conductivity controller</b> .....	<b>31</b>
Connecting an LRGT 1x-x conductivity transmitter (4 - 20 mA) with earthing point .....	31
<b>Electrical connection - LRR 1-52, LRR 1-53</b> .....	<b>32</b>
Connecting the 24 V DC power supply .....	32
Connecting the MIN/MAX/CLOSED/OPEN output contacts .....	32
Notes on connecting inductive loads .....	32
Connecting an LRG 16-9 conductivity electrode .....	32
Connecting an LRGT 1x-x conductivity transmitter .....	33
Connecting the actual value/manipulated variable output (4 - 20 mA) .....	33
Connecting the standby input (24 V DC) .....	33
Connecting the potentiometer (0 - 1000 $\Omega$ ) .....	33
<b>Connecting the data line between the conductivity controller and the URB 55</b> .....	<b>34</b>
Connecting the SPECTORmodul bus system .....	34
<b>Changing the equipment settings</b> .....	<b>35</b>
<b>Status display on the LRR 1-52, LRR 1-53</b> .....	<b>37</b>
<b>Visual display and operating unit URB 55</b> .....	<b>38</b>
Switching on the supply voltage .....	38
<b>Operation and navigation</b> .....	<b>39</b>
User interface (example) .....	39
Colour coding of input and status fields .....	39
Automatic functions .....	40
Entering parameters using the virtual keypad .....	40
Parameter input with password protection .....	41
Scroll bar for long lists and menus .....	41
<b>Icons and functions - LRR 1-52, LRR 1-53</b> .....	<b>42</b>
<b>The home screen of the LRR 1-52, LRR 1-53 conductivity controller</b> .....	<b>45</b>
<b>Alarms and error messages</b> .....	<b>46</b>
Opening the Alarm History - full list of all alarms .....	47
<b>System settings</b> .....	<b>48</b>
<b>System information</b> .....	<b>48</b>
<b>Setting the date/time</b> .....	<b>49</b>
<b>Password</b> .....	<b>49</b>
<b>Network settings</b> .....	<b>50</b>
<b>Data exchange via Modbus TCP</b> .....	<b>50</b>

# Contents

<b>Data exchange via Modbus TCP .....</b>	<b>51</b>
<b>VNC server / Remote software.....</b>	<b>51</b>
<b>Configuring the conductivity controller.....</b>	<b>52</b>
Setting the MIN/MAX switchpoints and set point .....	52
Trend log .....	54
Test - Testing the relays of the connected conductivity controller .....	55
Continuous blowdown valve - Setting the flushing interval and flushing time .....	56
Continuous blowdown valve - Calibrating the feedback potentiometer for the valve position display .....	57
Calibrating the conductivity electrode .....	58
Setting correction factor C .....	59
Setting the measuring range - LRR 1-52.....	60
Setting the measuring range - LRR 1-53.....	60
Setting the control parameters.....	61
Guide to setting control parameters .....	61
Setting automatic intermittent blowdown.....	62
<b>System malfunctions - URB 55 .....</b>	<b>63</b>
Display of system malfunctions in the alarm and error list using fault codes .....	63
Common faults and issues during use of the URB 55 .....	64
<b>System malfunctions - LRR 1-52, LRR 1-53.....</b>	<b>65</b>
Causes .....	65
Before starting systematic troubleshooting, check the installation and configuration.....	65
<b>What to do in the event of system malfunctions.....</b>	<b>66</b>
Checking installation and function .....	66
<b>Taking the LRR 1-52, LRR 1-53 out of service.....</b>	<b>66</b>
<b>Taking the URB 55 out of service.....</b>	<b>66</b>
<b>Disposal .....</b>	<b>67</b>
<b>Returning decontaminated equipment.....</b>	<b>67</b>
<b>Declaration of Conformity, Directives and Standards .....</b>	<b>68</b>

## Content of this Manual

### Product:

- Conductivity LRR 1-52
- Conductivity LRR 1-53
- Visual display and operating unit URB 55

### First edition:

BAN 850645-00/03-2021cm

### Applicable documents:

You can find the latest Installation & Operating Manuals on our website:  
<http://www.gestra.com>

### © Copyright

All rights reserved. Any misuse, particularly reproduction and dissemination to third parties, is not permitted. The General Terms & Conditions of GESTRA AG apply.

## Scope of delivery/Product package

### LRR 1-5x

- 1 x Conductivity LRR 1-52 or LRR 1-53

### URB 55

- 1 x visual display and operating unit URB 55
- 4 x retaining clips
- 1 x power supply connector
- 1 x data cable URB 55 (L = 5 m)

### LRR 1-5x + URB 55

- 1 x Installation & Operating Manual

## How to use this Manual

This Installation & Operating Manual describes the correct use of the LRR 1-52, LRR 1-53 conductivity controller in combination with the URB 55 visual display and operating unit. It applies to persons who integrate this equipment in control systems and install, bring into service, operate, maintain and dispose of this equipment. Anyone carrying out the above-mentioned activities must have read this Installation & Operating Manual and understood its contents.

- Read this Manual in full and follow all instructions.
- Please also read the instructions for use of any accessories.
- The Installation & Operating Manual is part of the product package. Keep it in an easily accessible location.

### Availability of this Installation & Operating Manual

- Make sure this Installation & Operating Manual is always available to the operator.
- If you pass on or sell the equipment to a third party, please also hand over the Installation & Operating Manual.

## Illustrations and symbols used

1. Action to be taken
- 2.

- Lists
  - ◆ Bullet points in lists

### A Keys to illustrations



Additional information



Read the relevant Installation & Operating Manual

## Hazard symbols in this Manual



Danger zone/Dangerous situation



Danger of death from electric shock

## Types of warning

### **DANGER**

Warning of a dangerous situation that results in death or serious injury.

---

### **WARNING**

Warning of a dangerous situation that may possibly result in death or serious injury.

---

### **CAUTION**

Warning of a situation that may result in minor or moderate injury.

---

### **ATTENTION**

Warning of a situation that results in damage to property or the environment.

---

## Specialist terms/Abbreviations

Here, we explain some abbreviations, specialist terms, etc., which are used in this Manual.

### Blowdown controller

A blowdown controller is a conductivity controller with special features for actuating continuous blow-down valves on steam boilers. It can also be used as a conductivity controller in other types of system.

### Continuous blowdown

Continuous and/or periodic removal of a certain (defined) quantity of boiler water via a continuous blow-down valve, e.g. BAE46 or BAE47.

To determine the total dissolved solids in the boiler water, its electrical conductivity is measured in  $\mu\text{S}/\text{cm}$ , although some countries also use ppm (parts per million) as the unit of measurement.

Conversion:  $1 \mu\text{S}/\text{cm} = 0.5 \text{ ppm}$ .

### Intermittent boiler blowdown

Intermittent blowdown is achieved by the abrupt opening of the intermittent blowdown valve for a period of around 3 seconds.

Time-based pulse/interval actuation of the intermittent blowdown valve optimises the removal of sludge from the boiler. The interval between the intermittent blowdown pulses can be set between 1 and 200 h (intermittent blowdown interval). The duration of intermittent blowdown can be set between 1 and 10 s. For large boilers, repeated intermittent blowdown pulses may be required. Repetition can be set between 1 and 10 with an interval from 1 – 10 seconds (pulse interval).

### External intermittent blowdown

If more than one steam boiler is connected to a single blowdown receiver, simultaneous blowdown is not permitted. In this case, an external interlock control can monitor and control the individual blowdown operations.

### Temperature compensation

The electrical conductivity of water changes as the temperature falls or rises. To obtain meaningful readings, it is therefore necessary to base the measurements on the reference temperature of 25 °C, and to correct the measured conductivity using the temperature coefficient tC.

### Cell constant

The cell constant is a geometric variable of the conductivity electrode and is taken into account when calculating the conductivity. However, this constant may change during operation, e.g. due to dirt deposits on the measuring electrode.

If a reference measurement yields a result that differs from the indicated conductivity value, first check the temperature compensation.

Modify the cell constant only if the temperature coefficient setting is no longer adequate for correct compensation. In this case, change the cell constant until the reading and the indicated conductivity match.



## Specialist terms/Abbreviations

### **Flushing the continuous blowdown valve**

The continuous blowdown valve can be flushed automatically to prevent it from sticking. In this case, the continuous blowdown valve is actuated at intervals (flushing interval) and opened for a certain time (flushing time). After the flushing time, the valve moves to the position set by the control.

### **Operating position of the continuous blowdown valve**

The operating position of the continuous blowdown valve ensures that the electrode comes into contact with a representative amount of boiler water.

### **Standby mode (conductivity control)**

To prevent loss of water, continuous blowdown control and automated intermittent blowdown (if enabled) can be disabled in standby mode or when the burner is switched off. The continuous blowdown valve moves to CLOSED position, triggered by an external control command. The MIN/MAX limits and monitoring function remain active in standby mode.

When the equipment is back in normal mode, the continuous blowdown valve returns to the control position. In addition, an intermittent blowdown pulse is triggered (if automated intermittent blowdown is enabled and a blowdown interval and blowdown time have been set).

### **Pb (proportional band)**

The proportional band enables the controller amplification to be adapted to suit the controlled system. For further information, see page 61, guide to setting control parameters.

### **Ti (reset time)**

The integral element ensures that control deviations can be fully corrected, with no remaining deviation. For further information, see page 61, guide to setting control parameters.

### **Neutral zone**

If the actual value reaches the (set point +/- of the neutral zone), the manipulated variable does not change in this range, see page 61.

### **PI controller**

Controller with proportional (P) and integral (I) control.

### **LRR .. / LRG .. / LRGT .. / URB ..**

GESTRA equipment and type designations, see page 10.

### **SELV**

Safety Extra Low Voltage

## Usage for the intended purpose

LRR 1-52 and LRR 1-53 conductivity controllers can be used in combination with LRG 1x-x conductivity electrodes and LRGT 1x-x conductivity transmitters as conductivity controllers and limiters in pressurised steam and hot-water plants and in condensate and feedwater tanks. The conductivity controller indicates when MAX or MIN conductivity has been reached, opens or closes a continuous blowdown valve and can actuate an intermittent blowdown valve.

### Configuration, operation and visual display

The equipment is configured and operated and information is viewed via the URB 50 or URB 55 visual display and operating unit. The URB 55 is designed for installation in a control cabinet door or switch panel. It may only be used when correctly installed. If you are using a URB 50, please pay attention to the information in Installation & Operating Manual "LRR1-52-LRR1-53-URB50".

### Overview of possible unit combinations

Conductivity controller	Conductivity electrode/transmitter	Visual display and operating unit
LRR 1-52	LRG 12-2 LRG 16-4 LRG 16-9 LRG 17-1 LRG 19-1	URB 55
LRR 1-53	LRGT 16-1 / 16-2 / 16-3 / 16-4 LRGT 17-1 / 17-2	

**Fig. 1**

#### Key to Fig. 1:

LRR = conductivity controller

LRG = conductivity electrode

LRGT = conductivity transmitter

URB = visual display and operating unit



To ensure the proper use of equipment for all types of use, please also read the Installation & Operating Manuals for the system components used.

- You can find the latest Installation & Operating Manuals for the system components named in **Fig. 1** on our website:  
<http://www.gestra.com>

## Usage for the intended purpose

### IT security and rules for the use of Ethernet devices

The plant operator is responsible for the security of his/her IT network and must take appropriate action to protect equipment, systems and components from unauthorised access.

#### Pay attention to the following instructions when using Ethernet devices in your system:

- Do not connect equipment, systems or components to an open network, such as the internet, without safeguards in place.
- To fully protect a PLC runtime system on a control system that is available on the internet, the use of common security mechanisms (firewall, VPN access) is absolutely essential.
- Make sure access to all components is restricted to authorised persons.
- Change default factory passwords before bringing into service for the first time!
- Deploy defence in depth mechanisms in your system security, to restrict access and control to individual products and networks.

## Improper use



---

**There is a danger of death due to explosion if the equipment is used in potentially explosive atmospheres.**

---

Do not use the equipment in potentially explosive atmospheres.

---

## Basic safety notes



### There is a risk of electric shock during work on electrical systems.

- Always switch off the voltage to the equipment before performing work on the terminal strips.
- Check that the system is not carrying live voltage before commencing work.



### Faulty equipment is a danger to system safety.

- If the LRR 1-52, LRR 1-53 conductivity controller does not behave as expected, it may be faulty.
- Perform failure analysis.
- Only replace faulty equipment with identical equipment from GESTRA AG.

## Required personnel qualifications

Activity	Personnel	
Integration in control system	Specialist staff	Plant designer
Installation/electrical connection/ bringing into service	Specialist staff	Electrician/installer
Operation	Boiler service technician	Staff trained by the plant operator
Maintenance work	Specialist staff	Electrician
Setup work	Specialist staff	Plant construction

Fig. 2

## Notes on product liability

The manufacturer cannot accept any liability for damages resulting from improper use of the equipment.

## Function

The LRR 1-52, LRR 1-53 conductivity controller is a 3-position stepping controller. It evaluates the signals from a conductivity electrode (e.g. LRG 16-60, LRG 16-61 or LRG 17-60) or conductivity transmitter.

The conductivity controller indicates when MAX or MIN conductivity has been reached, opens or closes a continuous blowdown valve and can actuate an intermittent blowdown valve.

Function tests and failure diagnosis can be performed using the URB 55 visual display and operating unit.

### Behaviour when MIN/MAX conductivity is reached

If the minimum or maximum conductivity is reached, the appropriate output contact is opened.

### What happens if the MAX limit is exceeded

- If used as a conductivity limiter, the LRR 1-52, LRR 1-53 conductivity controller does not interlock automatically when the MAX limit is exceeded.

### Possible combinations of functions and equipment

Combining the LRR 1-52, LRR 1-53 conductivity controller with the conductivity electrodes, conductivity transmitters and URB 55 visual display and operating unit provides the following common functions:

Conductivity controller	LRR 1-52	LRR 1-53
Conductivity measurement with an LRG 1-... conductivity electrode and separate Pt 100 resistance thermometer (TRG 5-...) <b>or</b> Conductivity measurement with an LRG 16-9 conductivity electrode with integrated resistance thermometer.	●	
Evaluating the temperature-compensated current signal of a connected LRG T 1x-x conductivity transmitter.		●
3-position stepping controller with proportional plus integral control (PI controller) and actuation of an electrically operated continuous blowdown valve.	●	●
MAX alarm when the conductivity limit is exceeded.	●	●
MIN alarm when conductivity drops below the minimum limit. Alternatively, MIN relay for automated intermittent blowdown.	●	●
The valve position can be displayed if a potentiometer is connected (in the continuous blowdown valve). The valve position is then shown on the URB 55 visual display and operating unit.	●	●
Switchable (DIP3) actual value/manipulated variable output, e.g. for remote actual value display or direct connection to a continuous blowdown valve (manipulated variable output)	●	●
Volt-free input 24 V DC (standby) for inputting an external command Control OFF / Valve CLOSED / Intermittent blowdown OFF	●	●

**Fig. 3**

## Function

Visual display and operating unit	URB 55
Display of actual value X (bar chart in $\mu\text{S}/\text{cm}$ or ppm)	●
Display of valve position Yw (bar chart in %)	●
Setting the measuring range	●
Display/setting control parameters	●
Trend log	●
Display and list of faults, alarms and warnings	●
Testing MIN/MAX output relays or actuating the intermittent blowdown valve	●
Manual/automatic mode	●
Password protection	●
Level and conductivity controllers can be operated simultaneously	●

**Fig. 4**

## Technical data - LRR 1-52, LRR 1-53

### Supply voltage

---

- 24 V DC +/-20 %

### Power consumption

---

- Max. 5 VA

### Current input

---

- Max. 0.3 A

### Reset hysteresis

---

- MAX limit: - 3 % of set MAX limit (factory default)
- MIN limit: - 3 % of set MIN limit (factory default)

### Required external fuse

---

- 0.5 A M

### Input/output

---

- Interface for data exchange with the URB 55 visual display and operating unit

### Inputs

---

- 1 x analogue input for potentiometer 0 - 1000  $\Omega$ , two-wire connection (display of valve position)
- 1 x volt-free input 24 V DC (standby) for inputting an external command  
Control OFF / Valve CLOSED / Intermittent blowdown OFF

### Outputs

---

- **Continuous blowdown valve (CLOSED/OPEN) \***
  - ◆ 2 x volt-free relay contacts (changeover relays) \*\*
  - ◆ Maximum switching current - 8 A at 250 V AC / 30 V DC -  $\cos \varphi = 1$  \*\*
- **MIN/MAX alarm \***
  - ◆ 2 x volt-free relay contacts (changeover relays) \*\*
  - ◆ Maximum switching current - 8 A at 250 V AC / 30 V DC -  $\cos \varphi = 1$  \*\*

or

- **MAX alarm and MIN relay as intermittent blowdown valve \***
  - ◆ 1 x volt-free relay contact (changeover relay) - intermittent blowdown valve \*\*
  - ◆ 1 x volt-free relay contact (changeover relay) - MAX alarm \*\*

\* Inductive loads must have interference suppression (RC combination) as per the manufacturer's specification

\*\* Contact material AgNi0.15, AgSn02

### Analogue output

---

- 1 x actual value output 4 - 20 mA, e.g. for an actual value display
- Max. load resistance 500  $\Omega$
- Inductive loads must have interference suppression (RC combination) as per the manufacturer's specification

## Technical data - LRR 1-52, LRR 1-53

### Indicators and controls

---

- 1 x multicolour LED (orange, green, red)
  - ◆ orange = power up
  - ◆ green = running
  - ◆ red = malfunction
- 1 x 4-pole code switch for setting the controller group and baud rate

### Protection class

---

- II double insulated

### IP rating to EN 60529

---

- Housing: IP 40
- Terminal strips: IP 20

### Electrical safety

---

- Degree of contamination 2 for installation in control cabinet with protection rating IP 54

### Admissible ambient conditions

---

- Service temperature: - 10 °C – 55 °C (0 °C – 55 °C at power-on)
  - Storage temperature: - 20 °C – 70 °C \*
  - Transport temperature: - 20 °C – 80 °C (< 100 hours) \*
  - Air humidity: max. 95 %, non-condensing
- \* Only switch on after a 24-hour defrosting period

### Housing

---

- Housing material: Lower section of black polycarbonate (glass-fibre reinforced), front of grey polycarbonate
- 2 x 15-pole terminal strips, removable separately
- Max. cross-section per screw terminal:
  - ◆ 1 x 4.0 mm<sup>2</sup> solid, or
  - ◆ 1 x 2.5 mm<sup>2</sup> stranded with sleeve, or
  - ◆ 2 x 1.5 mm<sup>2</sup> stranded with sleeve
- Housing attachment: Mounting clip on support rail TH 35 (to EN 60715)

### Weight

---

- Approx. 0.5 kg



## Technical data - URB 55

### Supply voltage

---

- 24 V DC (±) +/- 20 %

### Power consumption

---

- Max. 14.4 W

### Current input

---

- Max. 0.6 A (at 24 V)

### Required external fuse

---

- 10 A

### Data transmission interfaces

---

- 2 x Ethernet 10/100 Mbit switched (Modbus TCP/IP)
- 1 x USB host port (versions 2.0 and 1.1)
- 1 x slot for SD card

### Indicators and controls

---

- Capacitive 5" touchscreen with LED backlight
- Resolution 800 x 480 pixels (WVGA)
- Brightness 200 Cd/m<sup>2</sup>, dimmable
- Size (field of view) 110 mm x 65 mm

### IP rating

---

- Front: IP 66
- Back: IP 20

### Admissible ambient conditions

---

- Service temperature: 0 °C – 60 °C
- Storage temperature: -20 °C – 70 °C
- Transport temperature: -20 °C – 70 °C
- Air humidity: 5 % – 85 % relative humidity, non-condensing

### Housing

---

- Material: Front (metal/glass) / rear (metal electronics housing)
- Housing attachment with the supplied fastening elements
- Intended for installation in a control cabinet or switch panel

### Dimensions, see page 25

---

- Front panel (W x H) 147 x 107 mm
- Switch panel cutout (W x H) 136 mm x 96 mm
- Depth 52 mm + 8 mm protruding

## Technical data - URB 55

### Weight

---

- Approx. 1 kg

### Internal battery, permanently installed, non-replaceable

---

- Type: Lithium-ion, battery is charged automatically



If the equipment is out of service for six months or more, we recommend connecting it to the supply voltage for one day, to recharge the battery.

## Factory settings - LRR 1-52, LRR 1-53

The conductivity controller is delivered with the following factory settings:

- Code switch setting (sliding switch, white):

### LRR 1-52

- Configuration, see page 36 / **Fig. 19**

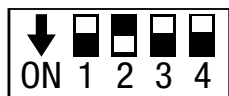

S 1 = OFF  
S 2 = ON  
S 3 = OFF  
S 4 = OFF

- Measuring range: 0.5 to 10000  $\mu\text{S/cm}$
- Correction factor C LRG: 1 cm-1
- Temperature compensation: Switched off
- Temperature coefficient: 2.1 % / °C

### LRR 1-53

- Configuration, see page 36 / **Fig. 19**

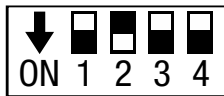

S 1 = OFF  
S 2 = ON  
S 3 = OFF\*)  
S 4 = OFF

- Measuring range: 0.5 to 6000  $\mu\text{S/cm}$   
(\*) from controller software 311178.13

### LRR 1-52, LRR 1-53

- MAX switchpoint: 6000  $\mu\text{S/cm}$
- MIN switchpoint: 500  $\mu\text{S/cm}$
- Reset hysteresis: MAX limit 3 % of set limit (factory default)
- Set point: 3000  $\mu\text{S/cm}$
- Proportional band (Pb):  $\pm 20$  % of set point
- Reset time (Ti): 0 seconds
- Neutral zone:  $\pm 5$  % of set point
- Valve runtime: 360 seconds
- Controlled operation: Automatic
- MIN relay function: MIN alarm
- 24h flushing: On
- Flushing interval: 0 hours
- Flushing time: 180 seconds. The set time takes effect twice. The valve moves to OPEN for 180 seconds and to CLOSED for 180 seconds.

### With actuation of an intermittent blowdown valve (MIN relay function = automatic intermittent blowdown)

- Intermittent blowdown interval: 24 hours
- Intermittent blowdown time: 3 seconds
- Number of intermittent blowdown pulses: 1
- Pulse interval: 2 seconds

## Factory settings - URB 55

The visual display and operating unit is delivered with the following factory settings:

- PWL 1: 111
- Conductivity in:  $\mu\text{S}/\text{cm}$
- VNC Service: ON
- Target IP: 192.168.0.84
- Subnet: 255.255.255.0
- Gateway: 192.168.0.1
- Modbus TCP: Off

# Example name plate / Marking - LRR 1-52, LRR 1-53

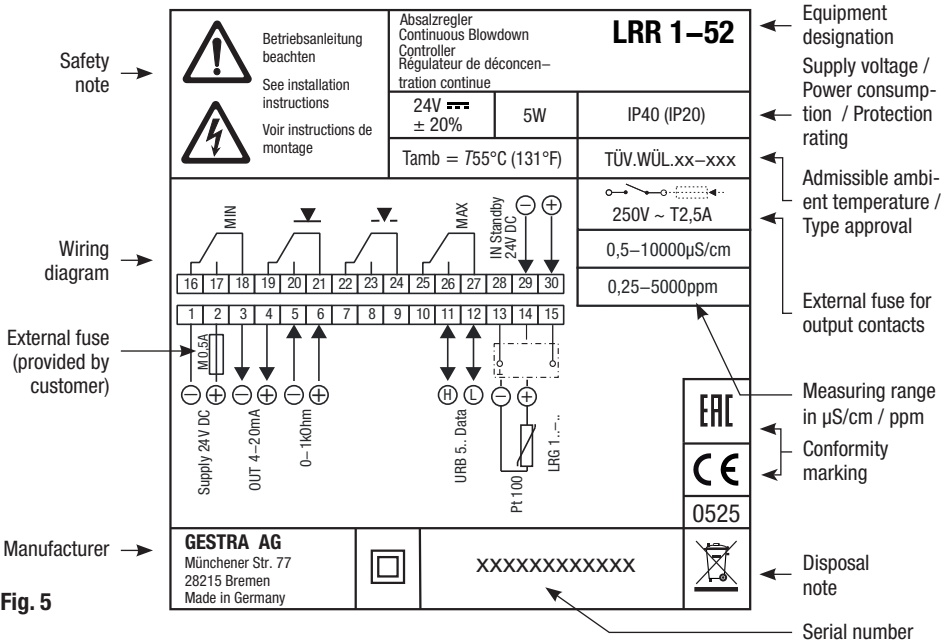

**Fig. 5**

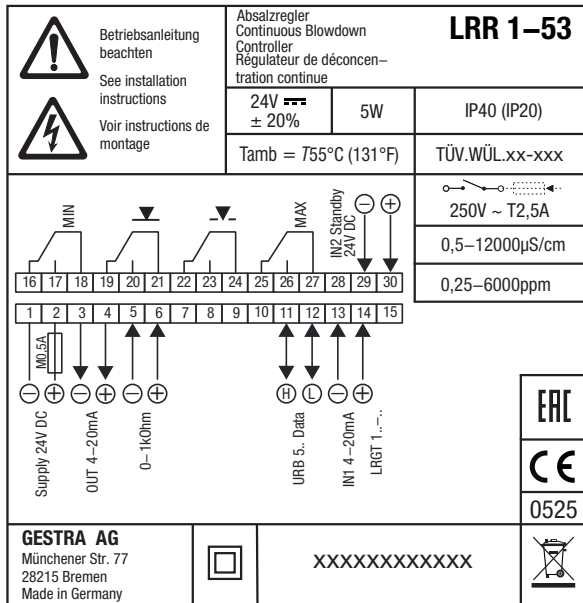

The date of production is printed on the side of the equipment.

## Example name plate / Marking - URB 55

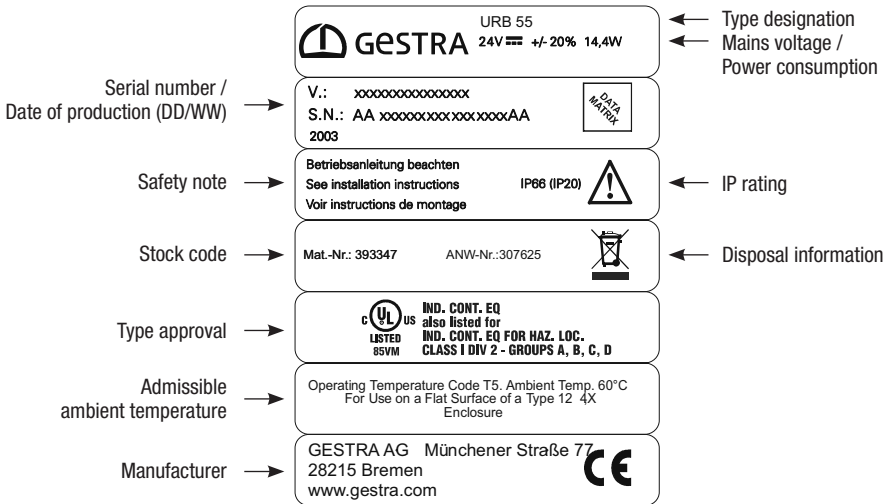

Fig. 7

## Functional elements and dimensions - LRR 1-52, LRR 1-53

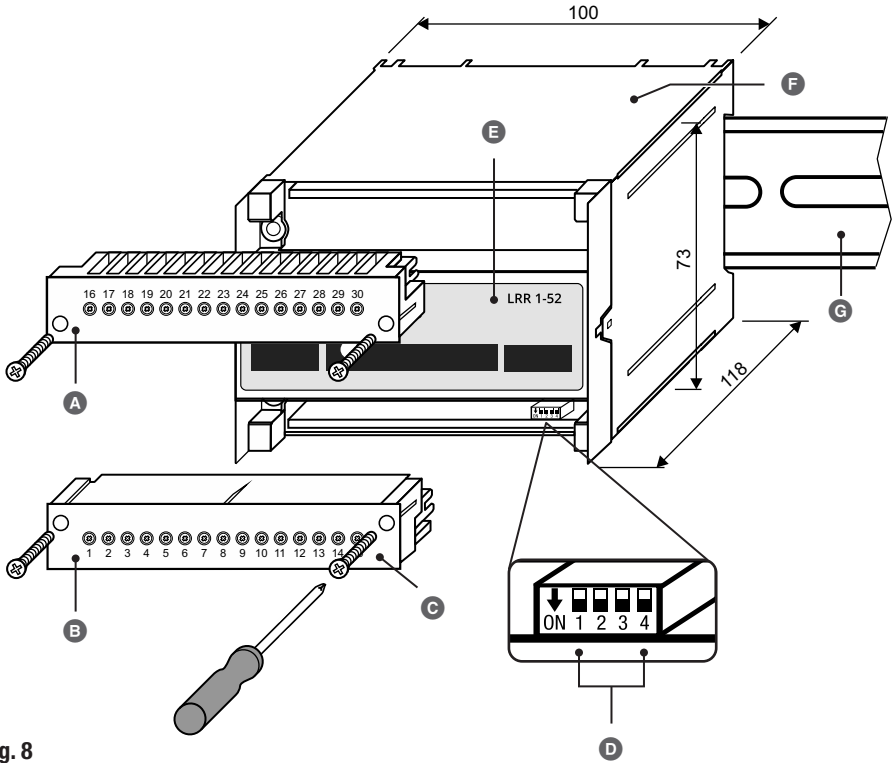

Fig. 8

- A** Upper terminal strip
- B** Lower terminal strip
- C** Fastening screws (M3)
- D** 4-pole code switch for configuring the conductivity controller
- E** Front membrane with status LED, see page 37
- F** Housing
- G** Support rail TH 35



The code switch can be accessed by disconnecting and removing the lower terminal strip.

Equipment settings, see page 36.

## Installing the LRR 1-52, LRR 1-53 conductivity controller

The LRR 1-52, LRR 1-53 conductivity controller snaps onto a TH 35 support rail in the control cabinet.

### **DANGER**



**There is a risk of electric shock during work on electrical systems.**

- Switch off the voltage to the plant before you install the equipment.
- Check that the system is not carrying live voltage before commencing work.

1. Switch off the voltage to the system, or secure the surrounding equipment in the control cabinet, if live, so it cannot be touched.
2. Carefully press the unit onto the support rail until the holder clips into place.



## Dimensions - URB 55

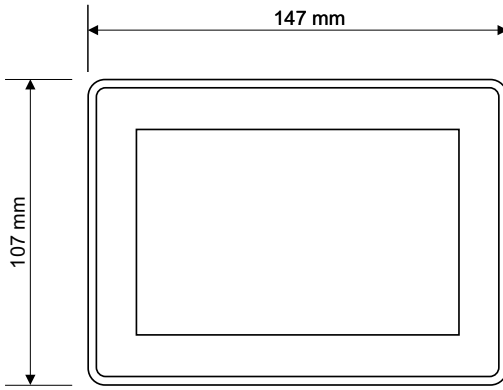
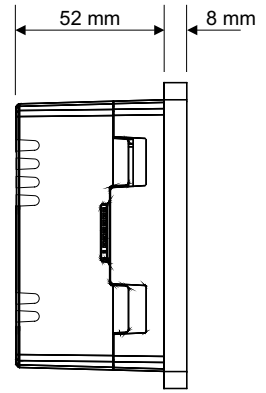

Fig. 9



## Required installation aperture in the control cabinet door or switch panel

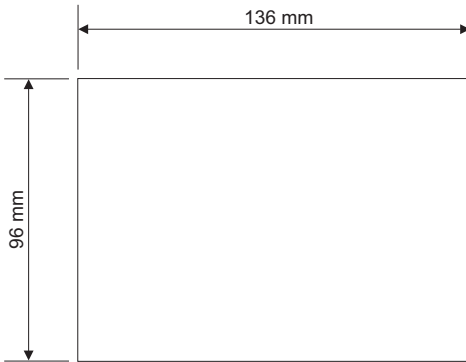

Fig. 10

## Installing the URB 55

The URB 55 is designed for installation in control cabinet doors or switch panels. The maximum panel thickness is 10 mm.

### For installation, you will need the following tools:

- A tool for cutting the installation aperture
- A Phillips PH2 screwdriver

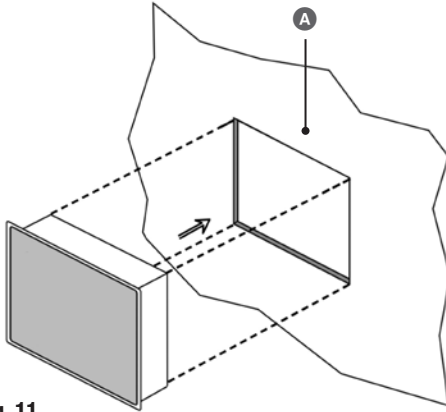

**Fig. 11**

- A** Installation aperture 136 x 96 mm, e.g. in a control cabinet door

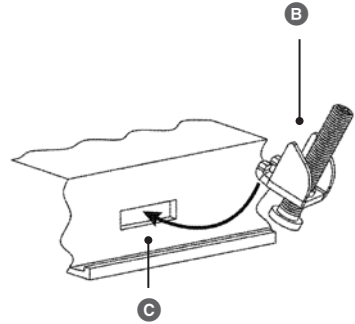

**Fig. 12**

- B** 4 x fastening elements (supplied)
- C** 4 x mounting holes in the equipment

1. Cut an aperture (see **Fig. 11**) in the control cabinet door or switch panel.
2. Stick the supplied gasket to the back of the display frame.
3. Carefully push the URB 55 visual display and operating unit through the aperture, making sure the gasket is correctly seated.
4. Insert the supplied fastening elements and tighten until the corners of the display frame are in contact with the gasket.
5. Remove the protective film from the display.

## Connecting the URB 55

### Ports and sockets on the back of the unit

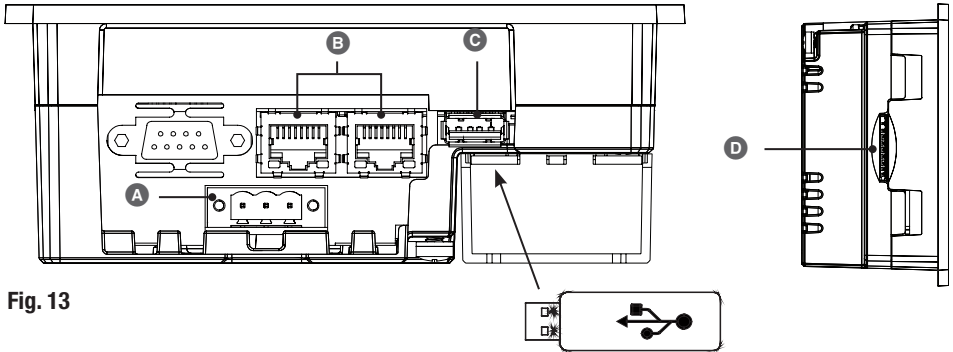

Fig. 13

- Ⓐ 1 x 3-pole connector for 24 V DC supply voltage
- Ⓑ 2 x Ethernet ports 10/100 Mbit switched (Modbus TCP/IP)
- Ⓒ 1 x USB host port (versions 2.0 and 1.1) for USB sticks with FAT32/FAT or exFAT file format
- Ⓓ 1 x slot for SD card with FAT32 file format (for service purposes) \*  
\* SDHC memory cards are not supported.

### Connection for 24 V DC supply voltage - pin assignment

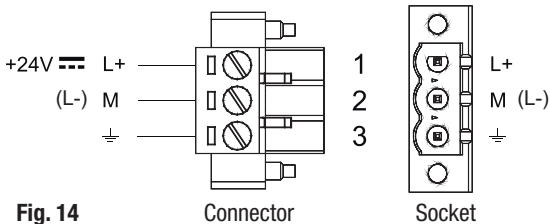
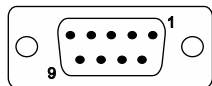

Fig. 14



Use a SELV (Safety Extra Low Voltage) power supply unit for connecting the supply voltage. To connect the supply voltage to the supplied 3-pole connector, use a cable with a max. conductor size of 2.5 mm<sup>2</sup>.

### Pin assignment of the data line between the URB 55 and the LRR 1-52, LRR 1-53



Pin 2 = Data\_L >> LRR 1-52, LRR 1-53 = terminal 12  
Pin 7 = Data\_H >> LRR 1-52, LRR 1-53 = terminal 11

Fig. 15

## Safety notes for electrical connection

### DANGER



**Incorrectly connecting the conductivity controller or any associated components is a danger to system safety.**

---

- Connect the conductivity controller and all associated components as shown in wiring diagrams **Fig. 16** to **Fig. 18** in this Manual.
  - Do not use unused terminals as jumpers or support terminals.
-

# Wiring diagram - LRR 1-52 conductivity controller

## Connecting LRG 1x-xx conductivity electrodes

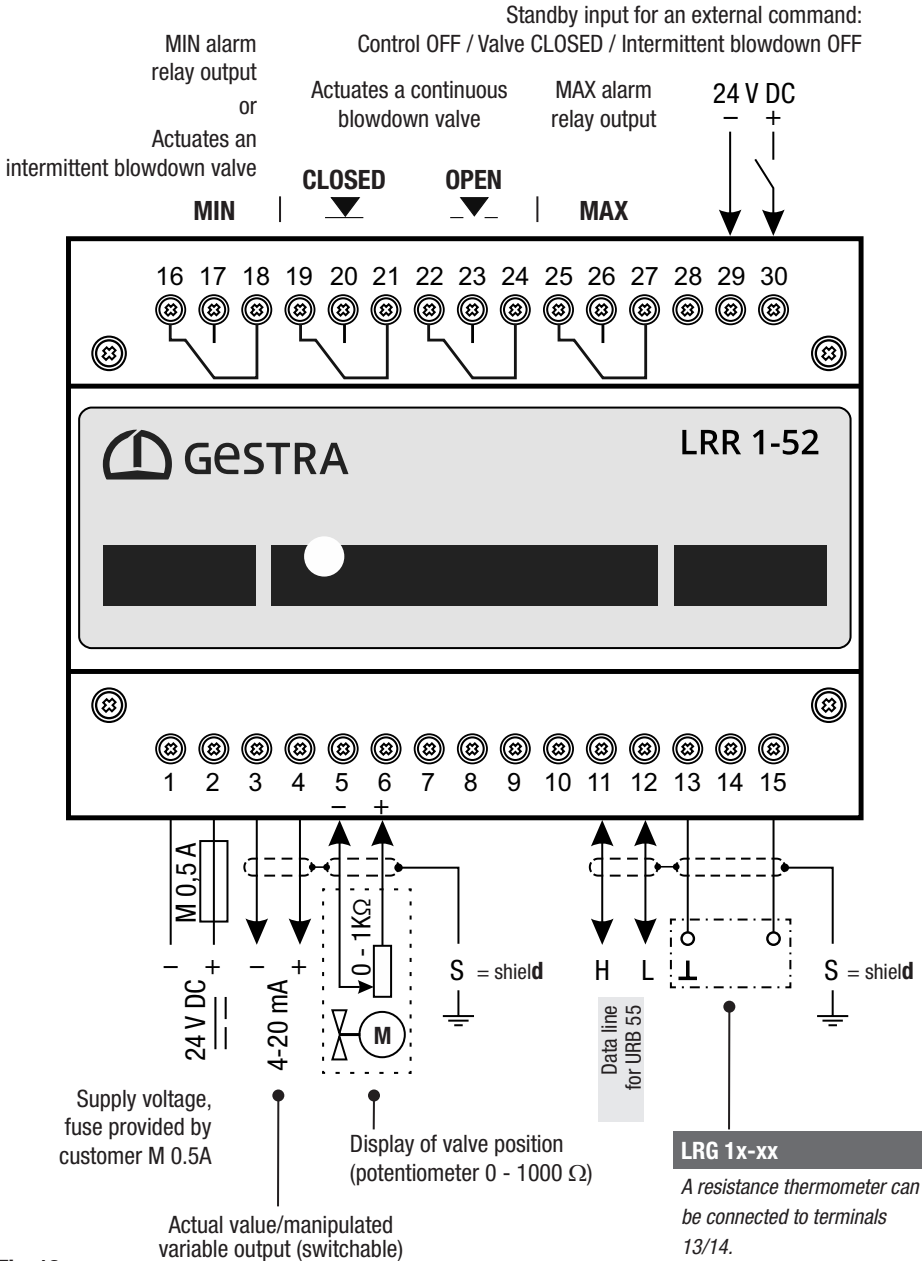

Fig. 16

# Wiring diagram - LRR 1-52 conductivity controller

## Connecting an LRG 16-9 conductivity electrode

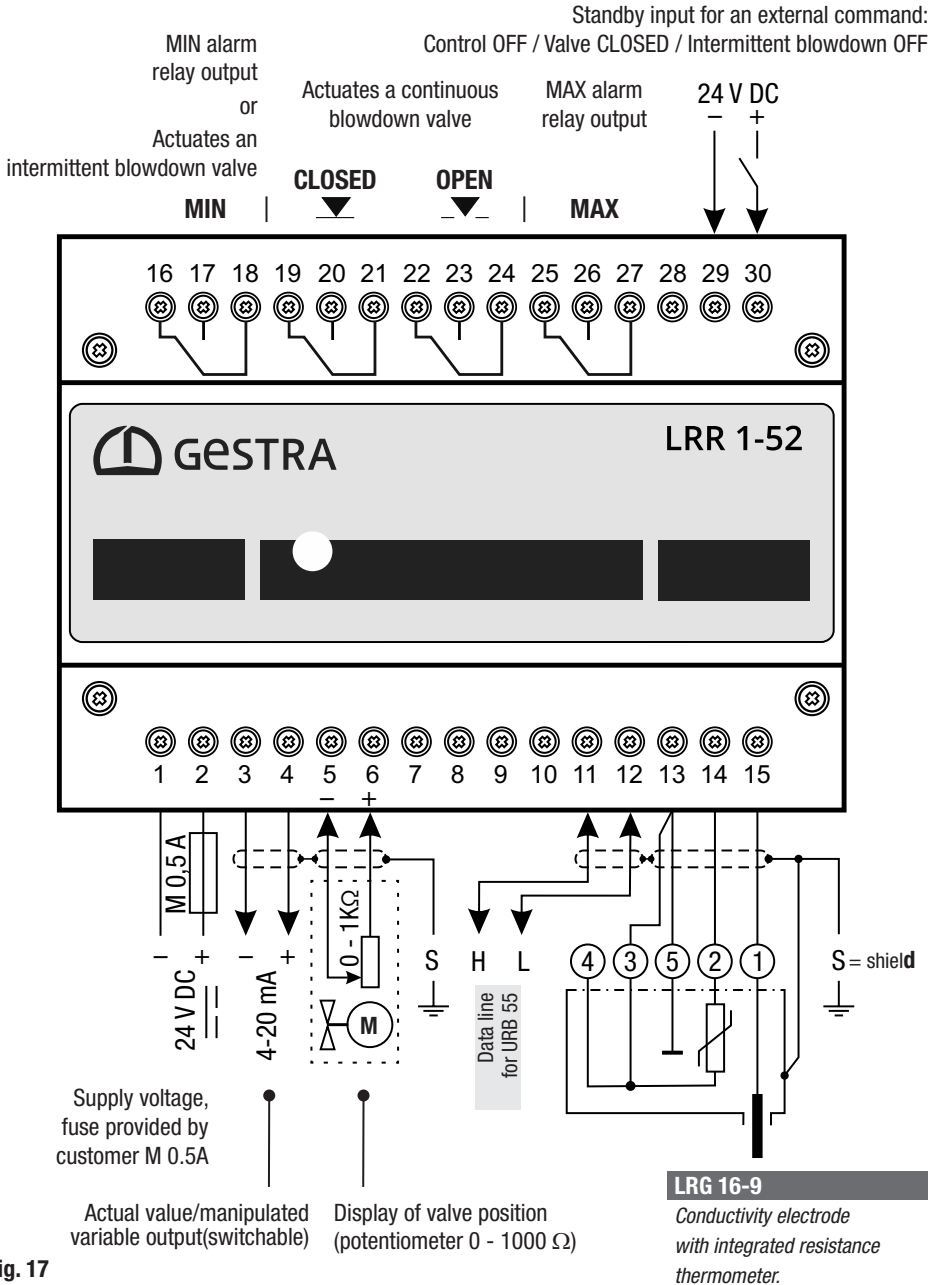

Fig. 17

# Wiring diagram - LRR 1-53 conductivity controller

## Connecting an LRGT 1x-x conductivity transmitter (4 - 20 mA) with earthing point

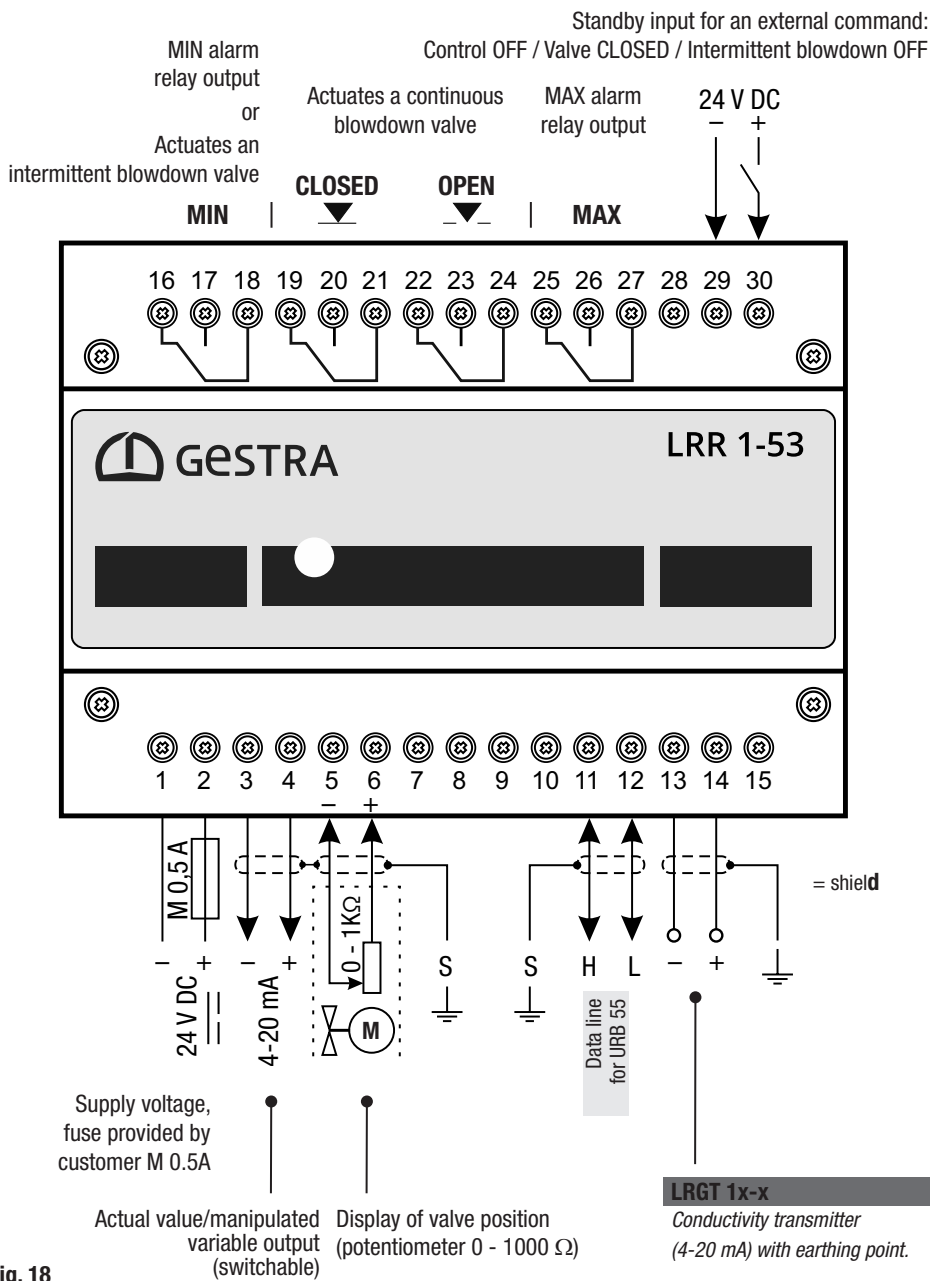

Fig. 18

## Electrical connection - LRR 1-52, LRR 1-53

### Connecting the 24 V DC power supply

- The LRR 1-52 or LRR 1-53 conductivity controller is supplied with 24 V DC.
- A safety power supply unit that delivers a Safety Extra Low Voltage (SELV) must be used to supply the equipment with 24 V DC.
- Use an M0.5A fuse as an external fuse.

### Connecting the MIN/MAX/CLOSED/OPEN output contacts

- Connect the outputs as shown in wiring diagrams **Fig. 16 to Fig. 18**.
- Only use the terminals specified in the wiring diagrams.
- Use an external slow-blow T2.5A fuse to protect the switching contacts.
- If used as a conductivity limiter, the LRR 1-52, LRR 1-53 conductivity controller does not interlock automatically when the MAX limit is exceeded.
- If the installation requires a lockout function, this must be implemented in the downstream (safety) circuit. This circuit must conform to the requirements of EN 50156.

### Notes on connecting inductive loads

All connected inductive loads, such as contactors and actuators, must have interference suppression using RC combinations as per the manufacturer's specifications.

### Connecting an LRG 12-2, LRG 16-4, LRG 17-1, LRG 19-1 conductivity electrode and a TRG 5-xx resistance thermometer

- Use a shielded, multi-core, twisted-pair control cable with a minimum conductor size of 0.5 mm<sup>2</sup>, e.g. LIYCY 4 x 0.5 mm<sup>2</sup>.
- Connect the conductivity electrode as shown in wiring diagrams **Fig. 16 to Fig. 17**.
- Route connecting cables separately from power cables.

### Connecting an LRG 16-9 conductivity electrode

- The LRG 16-9 conductivity electrode features an M12 A-coded 5-pole sensor connector. A pre-wired control cable (with plug and socket) is available in various lengths as an accessory for connecting the equipment.
- To connect the LRR 1-52 conductivity controller, please remove the plug and wire the terminal strip as shown in wiring diagrams **Fig. 16 to Fig. 17**.
- **If you are not using the pre-wired control cable:**  
Use a shielded, multi-core, twisted-pair control cable with a minimum conductor size of 0.5 mm<sup>2</sup>, e.g. LIYCY 5 x 0.5 mm<sup>2</sup>.  
In addition, connect a shielded socket to the control cable at the conductivity electrode end.
- Route connecting cables separately from power cables.



## Electrical connection - LRR 1-52, LRR 1-53

### Connecting an LRGT 1x-x conductivity transmitter

- Use a shielded, multi-core, twisted-pair control cable with a minimum conductor size of 0.5 mm<sup>2</sup>, e.g. LIYCY 4 x 0.5 mm<sup>2</sup>.
- Connect the conductivity transmitter as shown in the wiring diagram in **Fig. 18 an**.
- Maximum cable length = 100 m.
- Route connecting cables separately from power cables.



The conductivity transmitter must be connected to its own dedicated supply voltage.

### Connecting the actual value/manipulated variable output (4 - 20 mA)

- Please note the load resistance of max. 500  $\Omega$ .
- Use a shielded, multi-core, twisted-pair control cable with a minimum conductor size of 0.5 mm<sup>2</sup>, e.g. LIYCY 2 x 0.5 mm<sup>2</sup>.
- Maximum cable length = 100 m.
- Route connecting cables separately from power cables.

### Connecting the standby input (24 V DC)

- 24 V DC input, for external command: Control OFF, Valve CLOSED, Intermittent blowdown OFF.
- Maximum cable length = 30 m.

### Connecting the potentiometer (0 - 1000 $\Omega$ )

- Use a shielded, multi-core, twisted-pair control cable with a minimum conductor size of 0.5 mm<sup>2</sup>, e.g. LIYCY 2 x 0.5 mm<sup>2</sup>.
- Maximum cable length = 100 m.
- Route connecting cables separately from power cables.

## Connecting the data line between the conductivity controller and the URB 55

A pre-wired control cable with socket is supplied for connecting the equipment. For terminal assignment, see wiring diagrams **Fig. 16** to **Fig. 18**.

- If you are not using the pre-wired control cable, you must use a shielded, twisted-pair control cable with a minimum conductor size of 0.25 mm<sup>2</sup>, e.g. LIYCY 2 x 0.25 mm<sup>2</sup>.
- Maximum cable length 30 m.
- Wire the terminal strip as shown in wiring diagrams **Fig. 16** to **Fig. 18**.
- Wire the 9-pole D-sub connector as shown in **Fig. 15**.
- Connect the earthing point of the housing (URB 55) to the central earthing point in the control cabinet. Connect the shield just once to the central earthing point in the control cabinet.
- Route connecting cables separately from power cables.

### Connecting the SPECTORmodul bus system

Using the supplied data cable (5 m), connect the URB 55 to the first controller in the system. If the system has a second controller, position this immediately next to the first controller and connect terminals 11 and 12 of the two controllers to one another as follows:

- Terminal 11 of controller 1 to terminal 11 of controller 2
- Terminal 12 of controller 1 to terminal 12 of controller 2

## Changing the equipment settings

### **DANGER**



**Danger of death from electric shock if live connections on terminal strips are touched.**

- Always switch off the voltage to the equipment before performing work on the terminal strips.
- Check that the system is not carrying live voltage before commencing work.

If necessary, you can change the input and function of the LRR 1-52, LRR 1-53 conductivity controller at any time using code switch **Ⓛ** (see **Fig. 19**).



Make changes before installing the conductivity controller, when access is easier.

#### **You will need the following tools:**

- Slotted screwdriver, size 2.5, fully insulated
- Phillips screwdriver, size 1, fully insulated

#### **Proceed as follows:**

1. Switch off the supply voltage to the equipment or plant.
2. Unscrew and pull off the lower terminal strip, see **Fig. 8**.
3. Set code switch **Ⓛ** (see **Fig. 19**) as desired.
4. When your changes are complete, put the terminal strip back on and screw in place.

## Changing the equipment settings

Code switch  - sliding switch, white

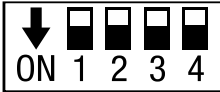

### Conductivity controller LRR 1-52, LRR 1-53

Code switch 				
S1	S2 *	S3 *	S4	Configuration
OFF				<b>MIN relay output as MIN alarm (factory setting)</b>
ON				MIN relay output for actuating an intermittent blowdown valve
	OFF			Node ID = 72 *
	ON			<b>Node ID = 69 - compatibility with older equipment (factory setting)</b>
		OFF		<b>Terminal 3/4 (Out 2) as actual value output (X) (factory setting) *</b>
		ON		Terminal 3/4 (Out 2) as manipulated variable output (Yw)
			OFF	<b>Electrical conductivity measured in <math>\mu\text{S/cm}</math> (factory setting)</b>
			ON	Electrical conductivity measured in ppm

\* Controller software version 311178.13 or later

**Fig. 19**

## Status display on the LRR 1-52, LRR 1-53

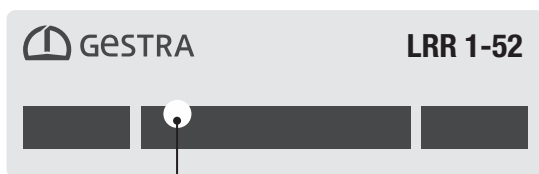

**Fig. 20**

Multicolour LED (orange/green/red),  
orange = power up/green = running/red = malfunction

## Visual display and operating unit URB 55

### Switching on the supply voltage

Please switch on the supply voltage for the LRR 1-5x conductivity controller and the URB 55 visual display and operating unit.

- For the controller(s), the LED first lights up orange, then green.
- The home screen of the URB 55 visual display and operating unit appears.
- If two controllers are connected to the visual display and operating unit, both controllers will be shown, see example.



If you tap one of the controller overview screens, a full screen for that controller will open on the display, see screenshot below.



- If just one controller is connected, the home screen of this controller will be shown (example).

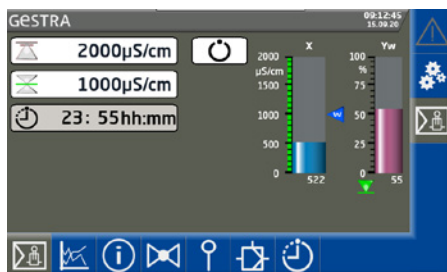

## Operation and navigation

The URB 55 is operated on the unit itself using the colour touchscreen or via Ethernet using remote software.

### User interface (example)

The URB 55 visual display and operating unit shows parameters, operating states, etc. on a display. The user interface of the URB 55 is divided into three areas:

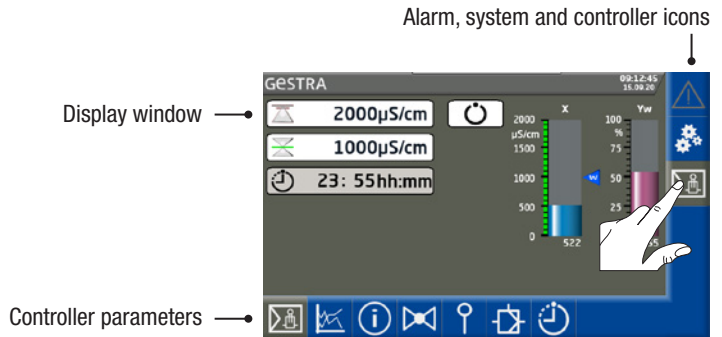

- The display window shows operating states and actual values.
- The icons open the associated parameter screens. These icons change dynamically and are either shown or hidden, depending on the current page and configuration.
- All entries and actions, e.g. opening setup menus and parameter screens, are initiated by tapping the buttons and input fields. The active screen has a grey background, see above.
- You can close smaller windows that appear by touching the screen outside of the window.

### Colour coding of input and status fields

Background colour	Description/function
Grey	Unavailable/static
White	Input field
Green	Status information, On, OK status
Red	Status information, Alarm status

Fig. 21

# Operation and navigation

## Automatic functions



If you do not input anything on the display for 10 minutes, the brightness is automatically dimmed and you will be logged off.

- If you do not input anything on the display for one hour, the program automatically returns to the home screen.
- If communication to the controller is disrupted, the message “Offline” appears in the general display area.

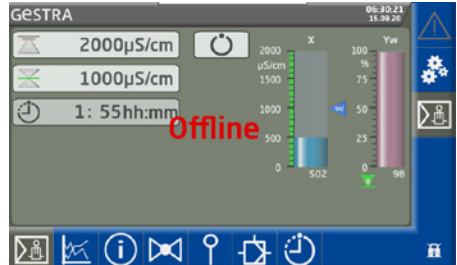

## Entering parameters using the virtual keypad

Tapping an input field opens a numeric virtual keypad.

The keypad shows the old value (Old) and the limits (Min/Max).



Your entries must remain within these limits.

### Function keys:

Delete last digit.

Confirm entry.

Discard entries and close keypad.

Old	Min	Max	
03	1	12	
			03
7	8	9	Esc
4	5	6	←
1	2	3	↵
.	0	-	↶



## Operation and navigation

### Parameter input with password protection

Password protection prevents parameters and settings from being changed by unauthorised persons. The password prompt appears automatically when you tap an input field.



If you do not input anything for 10 minutes, you will be logged off again.

#### Factory-set password:

- PWL = 111

#### Recommendation for initial setup

Log on using the factory setting, then safeguard your system by setting your own password.

#### Disabling parameter entries after successful

#### login

-  Parameter entries can be disabled by tapping the struck through padlock icon at the bottom right. The icon appears after you have logged in successfully.

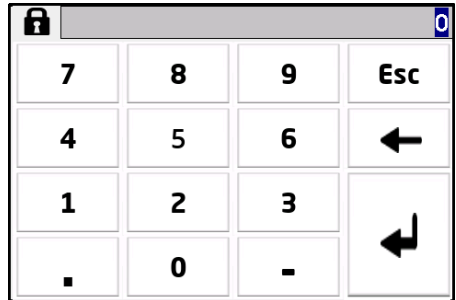





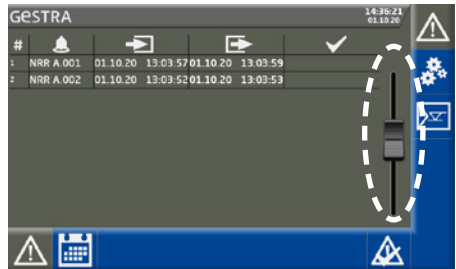

















### Scroll bar for long lists and menus

You can use the scroll bar to navigate up and down long lists and menus to select the desired parameters.



↑  
Scroll bar

## Icons and functions - LRR 1-52, LRR 1-53

Icon	Description	Icon	Description
	Alarm		Pump (mode) Only pump or valve mode is possible!
	Setup/settings		Valve (mode) Only pump or valve mode is possible!
	Home screen		Controller parameters
	Level controller		3C controller parameters
	Conductivity controller		Open valve
			Close valve
	Logged in with password / Log off		Alarm history
	Info		Reset alarm
	Time		Alarm number
	Password		Alarm coming
	Network		Alarm going
	Modbus TCP overview (optional)		Reset alarm

Icon	Description	Icon	Description
	New password		Valve/electrode raw value
	Confirm new password		Neutral zone
	Discard entry/Cancel		Water (flowrate)
	Apply entry/Confirm entry		Steam (flowrate)
	Switch on		Inlet control
	Switch off		Discharge control
	Datalog/Trend		Pump OFF threshold
	Electrode calibration		Pump ON threshold
	Set point		Stop pump in manual mode
	Manual (mode)		Start pump in manual mode
	Max alarm switchpoint Off / On		Automatic
	Min alarm switchpoint Off / On		Relay test
	Max switchpoint	<b>Pb</b>	Proportional band
	Min switchpoint	<b>Ti</b>	Reset time
	Set point	<b>Tt</b>	Valve runtime



















Icon	Description	Icon	Description
	24h flushing		Continuous/intermittent blowdown interval
	Flushing time		Setting 0 to 100 % / Valve/electrode raw value
	Damping		Correction factor
	Temperature compensation On / Off		Temperature coefficient
	Measuring range setup		Automatic intermittent blowdown
	Intermittent blowdown pulses		Intermittent blowdown time
	Intermittent blowdown active		Pulse interval
	24h flushing active		Controller on standby
	Operating position of continuous blowdown valve		Controller in manual mode

Fig. 22

## The home screen of the LRR 1-52, LRR 1-53 conductivity controller

The home screen provides an overview of the controller status and parameters. Bar charts display current readings and change colour depending on status. This enables you to rapidly assess the state of the system.

Icons on the bar charts indicate the status of the connected electrode.

### Opening the parameter screens:

Use the following buttons to open the controller parameter screens:



**Switchpoints,**  
see page 52



**Trend,**  
see page 54



**Test / Controller information,**  
see page 55



**Valve control,**  
see page 56



**Calibration of conductivity electrode,** see page 58



**Set controller parameters,**  
see page 61



**Set automatic intermittent blow-down,** see page 62

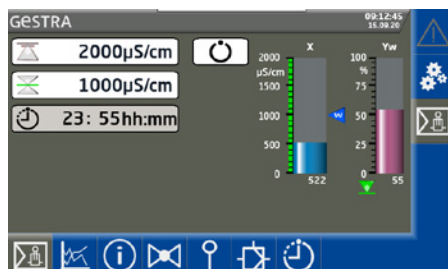

Further icons appear below the bar charts, depending on the configuration. These are explained in the sections below.



A B C D

- A Standby (mode)
- B Intermittent blowdown (active)
- C 24h flushing
- D Manual (mode)

## Alarms and error messages

### Status and colour of warning triangle:

- **Amber, flashing**  
Active alarms are present that have not been reset.
- **Amber, on continuously**  
Active reset alarms are present.
- **Grey**  
No alarms are active.

### Opening the alarm and error list



Open the list of active alarms.

### Description of the alarm and error list

Alarms and error messages are entered in the columns (Coming, Going, Reset) with a time stamp. The most recent alarm is always shown at the top of the list.

### Description of display:



The alarms are stored in the list with a code:

A = alarm / E = error



#### Coming

Time at which the event occurred.



#### Going

Time when the event ended.



#### Reset

Date and time the event was acknowledged and reset.

### Options:



Reset alarms and errors. Once reset, finished “alarms” are deleted.



Open the alarm history, see page 47.

#					
1	LRR A.001	01.12.20	12:24:22	01.12.20	12:24:27
2	LRR A.001	01.12.20	12:23:43	01.12.20	12:23:52
3	LRR A.001	01.12.20	12:23:08	01.12.20	12:23:13
4	LRR A.001	01.12.20	12:21:42	01.12.20	12:21:52
5	NRR E.007	01.12.20	12:19:21	01.12.20	12:19:22
6	NRR E.006	01.12.20	12:19:20	01.12.20	12:19:22
7	NRR E.005	01.12.20	12:19:20	01.12.20	12:19:22



Description of fault codes for controller, see page 63.

# Alarms and error messages

## Opening the Alarm History - full list of all alarms

All alarms are stored in an Alarm History. There is memory capacity for 300 alarms.



Alarms are stored in cycles and restored after a power failure.



Open the Alarm History.

#	Alarm ID	Start Time	End Time	Status
1	LRR A.001	01.12.20 12:24:22	01.12.20 12:24:27	✓
2	LRR A.001	01.12.20 12:23:43	01.12.20 12:23:52	
3	LRR A.001	01.12.20 12:23:08	01.12.20 12:23:13	
4	LRR A.001	01.12.20 12:21:42	01.12.20 12:21:52	
5	NRR E.007	01.12.20 12:19:21	01.12.20 12:19:22	
6	NRR E.006	01.12.20 12:19:20	01.12.20 12:19:22	
7	NRR E.005	01.12.20 12:19:20	01.12.20 12:19:22	

## System settings



Tapping the icon opens the menu containing the list of all connected controllers.

The current equipment firmware is also shown.

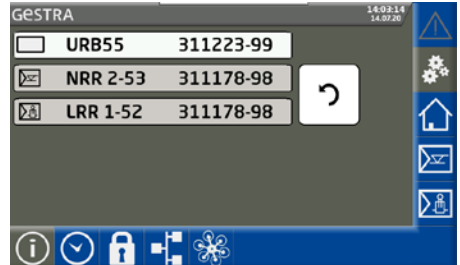

**URB 55** Tap the line with the URB 55 for > 2 s to see the runtime and OS of the URB 55.

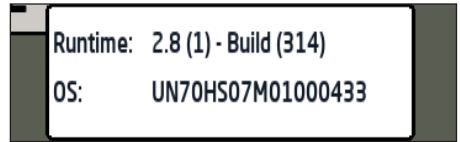

**Opening further menus:**



**System information**



**Set the date/time**



**Password**



**Network settings**



**Open Modbus TCP list (optional)**

## System information



Open the “*System Information*” menu and select the desired action.

### Description of display:

The connected controller(s) are shown with their software version.



Press the button to update a system or view installed (new) units.

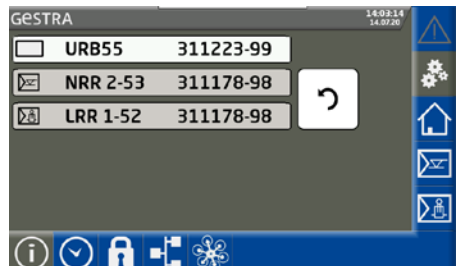



## Setting the date/time



Open the “*Date/Time*” menu and make the desired settings.

### Description of display/settings:

#### ■ Time / Date

Tap the appropriate field and set the date and time.

Confirm these changes to apply them.

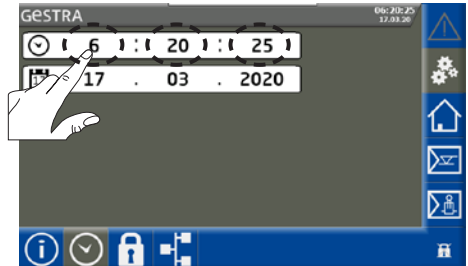

## Password

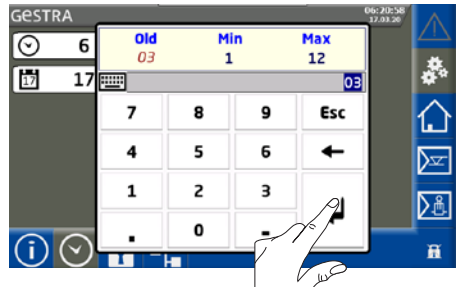

Open the “*Password*” menu.

**Factory setting:** 111

### Changing your password:

1. Tap the input field.
2. Enter the new password in the top line and confirm it by entering it again in the second line.



## Network settings



Open the “*Network settings*” menu.

Set the network to suit the requirements of the site and, finally, confirm your settings.

### Description of display:

- **Use DHCP:**
  - ◆ **No:** Static IP address
  - ◆ **Yes:** The IP address is obtained via DHCP
- **IP Address**  
The IP address of the URB 55.
- **Subnet mask**  
The current subnet mask.
- **Gateway**  
The IP address of the gateway.

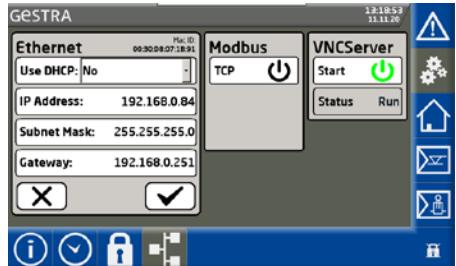

## Data exchange via Modbus TCP

The URB 55 visual display and operating unit has a Modbus TCP server. This enables all values to be forwarded to a higher-level control system or control centre.



For Modbus communication, switch on the connection using the TCP On button.

### Parameter:

- Modbus ID: 0
- Port: 502
- Modicon Modbus: based on 1

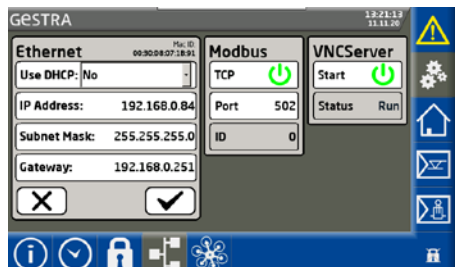

## Data exchange via Modbus TCP



If Modbus communication has been switched on, you can open the dynamic datapoint list.

- The raw data from the register is shown on this screen. There is a scroll bar at the side for scrolling through the data.
- You can find the latest datapoint list on our website at:  
<http://www.gestra.com/documents/brochures.html>

GESTRA						06.2017 17.03.20	
30000	1	30010	162	30100	2	30110	2
30001	62	30011	0	30101	0	30111	0
30002	50	30012	0	30102	0	30112	0
30003	20	30013	0	30103	20	30113	0
30004	85	30014	10	30104	2500	30114	12
30005	3	30015	2	30105	3	30115	5

## VNC server / Remote software

The URB 55 can be operated remotely from a PC using VNC remote software, e.g. UltraVNC Viewer. This allows a 1:1 display of the URB 55 on the computer.

To access the URB 55, use the previously set network parameters. You also need to switch on the service.

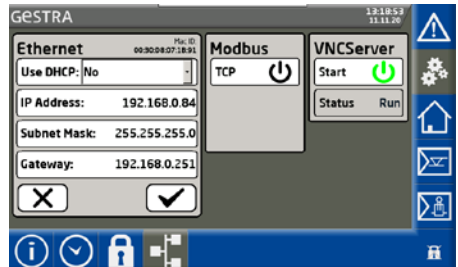

# Configuring the conductivity controller

## Setting the MIN/MAX switchpoints and set point



Open the parameter screen.

LRR 1-52 conductivity controller (example)

### Description of parameters:



MAX alarm switchpoint



Set point



MIN alarm switchpoint

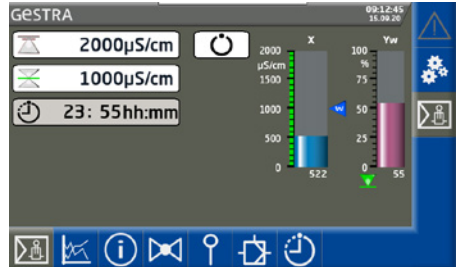

For each switchpoint, press the relevant button and enter the required value using the virtual keypad.



The icons in the buttons change colour to indicate switchpoints/alarm points that are too high or too low.

### Description of bar charts:

**X** Actual value

**W** Set point



The set point is shown in the actual value bar chart with a small arrow.

**Yw** Manipulated variable

### Change of colour on alarm

The bar chart column turns red in the event of an alarm.

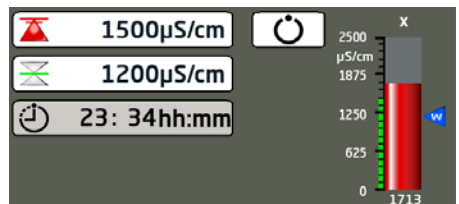

# Configuring the conductivity controller

Icons and functions that vary depending on configuration:

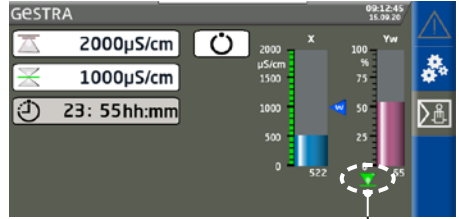

## Valve controller



The OPEN/CLOSED valve control is indicated by green valve icons in the manipulated variable bar chart.

## Automatic / Manual mode



The controller is normally in Automatic mode. Press the button to switch the controller to



Manual mode.

## Entering the manipulated variable



Here you can enter the valve position or manipulated variable in the input field that opens.

## Display of active intermittent blowdown



## Display of active 24h flushing

After a restart, 24h flushing (if switched on) is active and is shown on the home screen. This is also the case for all further 24h flushing.

## Display of remaining valve runtime (Ti) if 24h flushing is switched on

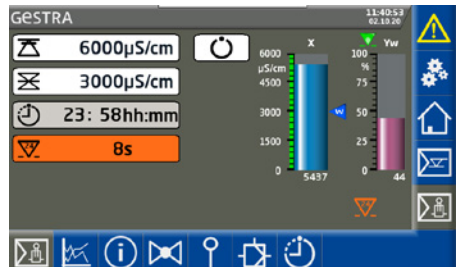

# Configuring the conductivity controller

## Trend log



Open the trend log.

### Description of display

The trend log shows the characteristic curve of the actual value (X), set point (W), manipulated variable (Yw) and alarm limits ( $\Delta$ ) over a 7-day period. The sampling rate is 5 seconds.

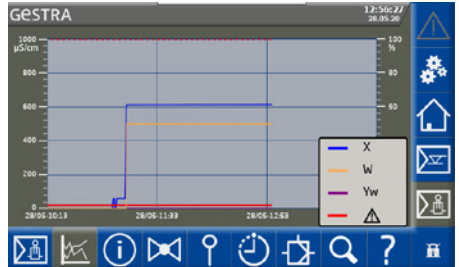

### Options:



Open the associated key.



Open a menu bar with further functions:



### Navigation:



Navigate forwards and backwards on the time axis using these buttons or by swiping horizontally



Zoom the display in/out using these buttons or using two fingers (pinch gesture)



Close the view

# Configuring the conductivity controller

## Test - Testing the relays of the connected conductivity controller



Open the Info / Test menu to test the alarm and switching contacts of the connected controller.



Press the button to initiate the relay test.

This causes actual tripping of relay contacts in the controller.



The relevant icons are shown in the top part of the screen, depending on the configuration (example).

The relay in the controller remains active as long as you are pressing the button.



Actual value output 4 - 20 mA, display of current actual value (X) \*

or



Manipulated variable output 4 - 20 mA, display of current manipulated variable (Yw) \*

\* Controller software version

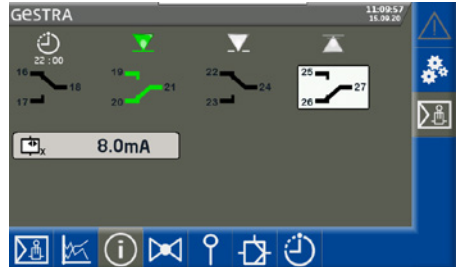

311178.13 or later

### View if configured as an intermittent blowdown controller

If the MIN relay is configured as an intermittent blowdown controller, the icons in the display change accordingly.

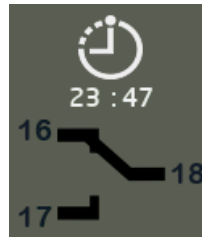

# Configuring the conductivity controller

## Continuous blowdown valve - Setting the flushing interval and flushing time



Open the “Valve” menu.

### Description of display/settings

#### Tt Valve runtime, see page 61

If the actual value/manipulated variable output is configured as a manipulated variable output (Yw), the valve runtime is no longer shown and therefore has no impact on control behaviour. The manipulated variable therefore changes rapidly.

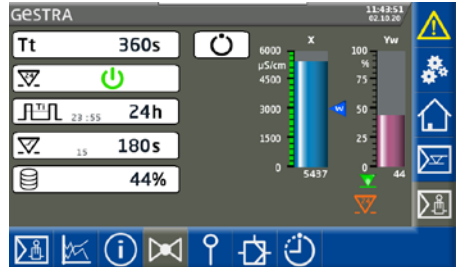

### Activate 24h flushing.



Press the button to activate 24h flushing.

### Setting the flushing interval and flushing time

You can enter the desired time, within their limits, in the input fields.

When the set interval has elapsed, the flushing interval is activated and moves the valve to “Open” for the set time.

When the set flushing interval has elapsed, the valve returns to the “Closed” position for the set time.

The incrementing times are shown in the parameters.



Feedback of this action is shown on the home screen, and in the bar charts, see page 45.

Flushing interval

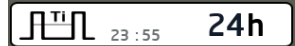

Flushing time

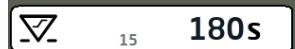

### Active parameters when a feedback potentiometer is connected to the conductivity controller.

The current valve position is shown in percent.





# Configuring the conductivity controller

## Continuous blowdown valve - Calibrating the feedback potentiometer for the valve position display



Even with a feedback potentiometer connected to the controller, the valve runtime still needs to be established and entered precisely.

Tt 360s

1. Tap the parameter display.  
The raw values then appear.

 76%

### 100 % (OPEN) / 0 % (CLOSED)

Calibrated valve positions.  
The calibrated raw data is shown in both fields.









#### Raw data

Indicates the current digital valve position.

100%	17441	<input checked="" type="checkbox"/>
	13226	
0%	33	<input checked="" type="checkbox"/>

## Performing calibration

2.  Press the Automatic button and switch to manual mode.
3.  Enter “0 %” as the manipulated variable (Yw).
4.  When the valve is in the **(CLOSED) end position**, confirm the valve position.
5.  The raw data from the central field is automatically entered in the 0 % (CLOSED) field.
6.  Next, enter “100 %” as the manipulated variable (Yw).
7.  When the valve is in the **(OPEN) end position**, confirm the valve position.
8.  The raw data from the central field is automatically entered in the 100 % (OPEN) field.

# Configuring the conductivity controller

## Calibrating the conductivity electrode



Open the menu.

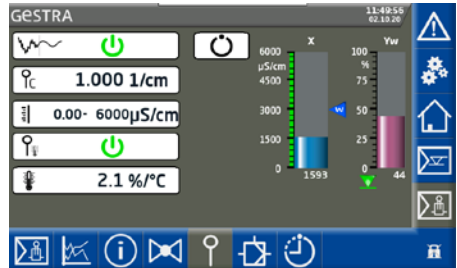

LRR 1-52 (example)

### Brief description of parameters:



#### Damping \*

This parameter is used to settle the oscillations of the input signal.

\* Controller software version  
311178.13 or later



#### Correction factor C, see page 59

During operation, the indicated conductivity may differ from the reference reading obtained from a reference measurement, e.g. due to soiling.

When the correction factor is entered, the display is adapted to the currently measured conductivity.



#### Measuring range (dependent on controller), see page 60

Enter the measuring range for your particular conductivity controller.



#### Temperature compensation On/Off



#### Set temperature coefficient

Proceed in the same way as when setting correction factor C.

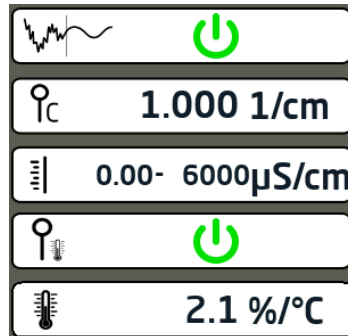

# Configuring the conductivity controller

## Setting correction factor C

### 1. Establish a reference reading.

Once operating temperature is reached, the conductivity of a sample of water must be measured.

### 2. Tap the “Correction factor C” input field.

### 3. Either type in the correction factor “C”

or

Enter the reference reading “ $X_{Ref}$ ” you previously measured.

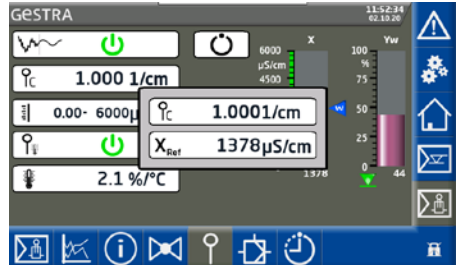

### Display after entering reference reading “ $X_{Ref}$ ”



Confirm the calculated correction factor “C”.



Reject the calculated correction factor “C”.

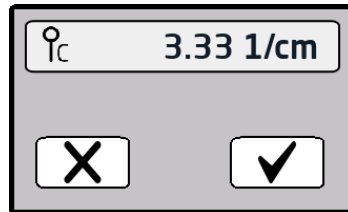

### Display when limit is exceeded

If correction factor “C” exceeds the limit 5 1/cm, a warning appears.

In this case, you have no choice but to reject the calculated correction factor “C”.



A value > 5 1/cm indicates heavy soiling of the conductivity electrode. The conductivity electrode must be cleaned.

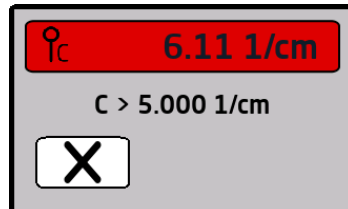

# Configuring the conductivity controller

## Setting the measuring range - LRR 1-52

Tap the input field and set the desired 100 % measuring range.

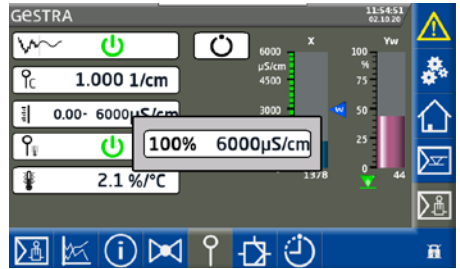

## Setting the measuring range - LRR 1-53

1. First bring the conductivity transmitter into service.



To do this, read the relevant Installation & Operating Manual.

2. Tap the input field.

You will see the screen containing factory-set measuring ranges.



3. Tap the measuring range that is set on the conductivity transmitter.

0,5-20 µS/cm	0,5-1000 µS/cm	0,5-12000 µS/cm	100-3000 µS/cm	50-3000 µS/cm
0,5-100 µS/cm	0,5-2000 µS/cm		100-5000 µS/cm	50-5000 µS/cm
0,5-200 µS/cm	0,5-6000 µS/cm		100-7000 µS/cm	50-7000 µS/cm
0,5-500 µS/cm	0,5-10000 µS/cm		100-10000 µS/cm	50-10000 µS/cm

# Configuring the conductivity controller

## Setting the control parameters



Open the control parameter screen.

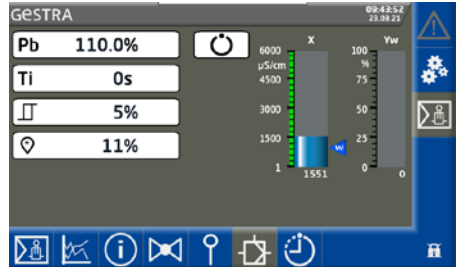

## Guide to setting control parameters

Parameter		Control deviation	Control valve
Proportional band Pb	> higher	Large remaining deviation	Responds slowly
	< lower	Small remaining deviation	Responds quickly and may open/close continually
	Example:	Measuring range 0 - 6000 µS/cm Set point SP = 3000 µS/cm Proportional band Pb = +/- 20 % of set point = +/- 600 µS/cm With the measuring range and set point mentioned above, the proportional band is then +/- 600 µS/cm or in the range 2400 µS/cm to 3600 µS/cm.	
Reset time Ti	> higher	Slow correction of deviations	Responds quickly
	< lower	Fast correction of deviations, the control loop may tend to overshoot	Responds slowly
Neutral zone	> higher	Correction of deviations starts with a delay	In this range, the manipulated variable does not change.
	< lower	Correction of deviations starts rapidly	Responds only if the control deviation is greater than the "neutral zone".
Valve runtime Tt			Establish the real valve runtime, e.g. from "Closed" to "Open" (0 - 100 %).
Operating position			Specified opening of the continuous blowdown valve. Closed during stand-by operation.

Fig. 23

# Configuring the conductivity controller

## Setting automatic intermittent blowdown

If the function “MIN relay for intermittent blowdown” is set on the code switch of the conductivity controller (see page 36, **Fig. 19**), you can assign parameters using the Automatic Intermittent Blowdown button.



Open the menu.



**Auto / Manual**

Switch between automatic intermittent blowdown and manual mode.

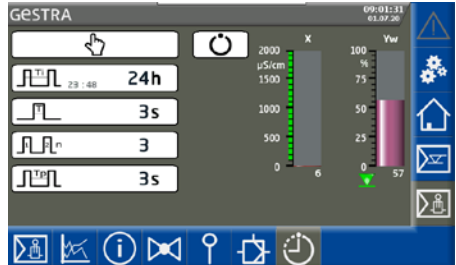

### Description of parameters:



**Initiate intermittent blowdown manually**

The display lights up orange when intermittent blowdown is active or has been initiated manually.



**Intermittent blowdown interval (in hours)**



**Intermittent blowdown time (in seconds)**

The intermittent blowdown valve is switched on regularly at set intervals and opens for the set intermittent blowdown time.



**Intermittent blowdown pulses**

Number of pulses



**Pulse interval (in seconds)**

Set the time between the individual intermittent blowdown pulses.



## System malfunctions - URB 55

### Display of system malfunctions in the alarm and error list using fault codes

Fault codes for the LRR 1-52 / LRR 1-53 conductivity controllers		
Fault code	Possible faults	Remedy
LRR Offline	No power supply	Check data line (terminals 11 + 12)
LRR NodeID	Wrong configuration	Set node ID (DIP 2) to ON, as there are two controllers
A.001	Above MAX switchpoint	-
A.002	Below MIN switchpoint	-
E.001	Below temperature sensor measuring range	Check Pt100 temperature sensor and replace if necessary Check electrical connection
E.002	Above temperature sensor measuring range	Check Pt100 temperature sensor and replace if necessary Check electrical connection <b>or</b> Switch off temperature compensation
E.005	Faulty conductivity electrode, measuring voltage < 0.5 V DC	Check conductivity electrode and replace if necessary Check electrical connection
	Faulty conductivity transmitter, measuring current < 4 mA	Check conductivity transmitter and replace if necessary Check electrical connection
E.001	Faulty conductivity electrode, measuring voltage > 7 V DC	Check conductivity electrode and replace if necessary
	Faulty conductivity transmitter, measuring current > 20 mA	Check electrical connection
E.011	Calibration points implausible/ wrong way round Valve: CLOSED (0 %) > OPEN (100 %)x	Recalibrate the potentiometer in the continuous blowdown valve
E.012	Lower and upper bounds of measuring range changed round	Reset measuring range
E.013	Switchpoints implausible MIN > MAX	Reset the switchpoints

All fault codes from E.001 to E.027 not listed here are available as reserves

**Fig. 24**

## System malfunctions - URB 55

### Common faults and issues during use of the URB 55

#### USB stick cannot read/write files

##### Remedy:

- Reboot the URB 55 with the USB stick inserted and perform the desired action again.
- The USB stick must have the file format FAT32.
- The USB stick may not be suitable for this data transfer.

#### The home screen remains blank

##### Remedy:

- The URB 55 is not properly connected to the data interface.  
When two units are connected, the conductivity controller does not switch.

#### Incorrect parameter display

##### Remedy:

Reboot the URB 55.



## System malfunctions - LRR 1-52, LRR 1-53

### Causes

System malfunctions occur if components have been incorrectly installed or configured, if the equipment has overheated, if there is interference in the supply network or electronic components are faulty.

**Before starting systematic troubleshooting, check the installation and configuration.**

### Installation:

- Check that the installation location complies with the admissible ambient conditions in terms of temperature, vibration, interference sources, etc.

### Wiring:

- Does the wiring conform to the wiring diagrams?
- Do the signal lines have the correct polarity?

### Configuration on the conductivity controller:

- Are the inputs and functions correctly set on code switch **D**?

### Configuration of electrodes:

- Are the electrodes correctly set and has the measuring range been calibrated?

## **DANGER**



### **There is a risk of electric shock during work on electrical systems.**

- Always switch off the voltage to the equipment before working on the terminal strips (installation, electrical connection, disassembly).
- Disconnect all poles of the supply cable from the mains and secure so they cannot be switched back on.
- Check that the system is not carrying live voltage before commencing work.

## What to do in the event of system malfunctions

### Checking installation and function

When you have remedied system malfunctions, perform a function test as follows.

- Check installation and function
- Check settings



In the event of malfunctions or faults that cannot be remedied with the aid of this Installation & Operating Manual, please contact our service centre or authorised agent in your country.

### Taking the LRR 1-52, LRR 1-53 out of service

1. Switch off the supply voltage and switch off the power to the equipment.
2. Check that the equipment is not live.
3. Unscrew and pull off the lower terminal strip, see **Fig. 8 A**; **B**
4. Release the slider holder on the base of the equipment and detach the conductivity controller from the support rail.

### Taking the URB 55 out of service

1. Switch off the supply voltage and secure so that it cannot be turned on again.
2. Unplug the mains connector from the unit.
3. Remove all plug and socket connections.
4. Unscrew the screws and remove the retaining clips.
5. Carefully push the unit out of the cutout in the door of the control cabinet.

## Disposal

Dispose of the conductivity controller in accordance with statutory waste disposal regulations.

## Returning decontaminated equipment

**If products have come into contact with media that are hazardous to health, they must be drained and decontaminated before being returned to GESTRA AG.**

Such media include solid, liquid or gaseous substances, mixtures of these, or radiation.

GESTRA AG can accept returned products only if accompanied by a completed and signed return note and also a completed and signed declaration of decontamination.



The return confirmation and declaration of decontamination must be attached to the outside of the return package, as processing will otherwise be impossible and the products will be returned to the sender at their expense.

### **Please proceed as follows:**

1. Let GESTRA AG know about the return beforehand by e-mail or phone.
2. Wait until you have received the return confirmation from GESTRA.
3. Fill out the return confirmation (and declaration of decontamination) and send it with the products to GESTRA AG.

## **Declaration of Conformity Directives and Standards**

For more information on the conformity of the equipment as well as applied Directives and Standards please refer to our Declaration of Conformity and associated certificates and/or approvals.

The Declaration of Conformity can be found online at [www.gestra.com](http://www.gestra.com) and associated certificates can be requested from:

### **GESTRA AG**

Münchener Straße 77

28215 Bremen

Germany

Telefon +49 421 3503-0

Telefax +49 421 3503-393

E-mail [info@de.gestra.com](mailto:info@de.gestra.com)

Web [www.gestra.com](http://www.gestra.com)

Note that Declarations of Conformity and associated certificates lose their validity if equipment is modified without prior consultation with us.

## For your notes

## For your notes

## For your notes



You can find our authorised agents around the world at: [www.gestra.com](http://www.gestra.com)

## **GESTRA AG**

Münchener Straße 77  
28215 Bremen  
Germany

Telefon +49 421 3503-0  
Telefax +49 421 3503-393  
E-Mail [info@de.gestra.com](mailto:info@de.gestra.com)  
Web [www.gestra.com](http://www.gestra.com)

## **UK Importer: GESTRA UK Ltd**

Unit 1 Sopwith Park, Royce Close,  
West Portway Business Park, Andover,  
Hampshire SP10 3TS  
United Kingdom