

High Efficiency Compressed Air Filter/
Regulators for use with GCV Control
Valves and Pneumatic Actuators

MPC1M, MPC2M and MPC2AM

- 1 Safety information
- 2 General product information
- 3 Installation and commissioning
- 4 Operation
- 5 Spare parts and maintenance



Intended use

Referring to the Installation and Maintenance Instructions, name-plate and Technical Information Sheet, check that the product is suitable for the intended use/application. The products comply with the requirements of the EU Pressure Equipment Directive / UK Pressure Equipment (Safety) Regulations and fall within the category 'SEP'.

It should be noted that products within this category are required by the Directive not to carry the  mark.

- i) The products have been specifically designed for use on compressed air, which is in Group 2 of the above mentioned Pressure Equipment Directive. The products' use on other fluids may be possible but, if this is contemplated, GESTRA should be contacted to confirm the suitability of the product for the application being considered.
- ii) Check material suitability, pressure and temperature and their maximum and minimum values. If the maximum operating limits of the product are lower than those of the system in which it is being fitted, or if malfunction of the product could result in a dangerous overpressure or overtemperature occurrence, ensure a safety device is included in the system to prevent such over-limit situations.
- iii) Determine the correct installation situation and direction of fluid flow.
- iv) GESTRA products are not intended to withstand external stresses that may be induced by any system to which they are fitted. It is the responsibility of the installer to consider these stresses and take adequate precautions to minimise them.
- v) Remove protection covers from all connections and protective film from all name-plates, where appropriate, before installation on steam or other high temperature applications.

Access

Ensure safe access and if necessary a safe working platform (suitably guarded) before attempting to work on the product. Arrange suitable lifting gear if required.

Lighting

Ensure adequate lighting, particularly where detailed or intricate work is required.

Hazardous liquids or gases in the pipeline

Consider what is in the pipeline or what may have been in the pipeline at some previous time. Consider: flammable materials, substances hazardous to health, extremes of temperature.

Hazardous environment around the product

Consider: explosion risk areas, lack of oxygen (e.g. tanks, pits), dangerous gases, extremes of temperature, hot surfaces, fire hazard (e.g. during welding), excessive noise, moving machinery.

1.6 The system

Consider the effect on the complete system of the work proposed. Will any proposed action (e.g. closing isolation valves, electrical isolation) put any other part of the system or any personnel at risk?

Dangers might include isolation of vents or protective devices or the rendering ineffective of controls or alarms. Ensure isolation valves are turned on and off in a gradual way to avoid system shocks.

1.7 Pressure systems

Ensure that any pressure is isolated and safely vented to atmospheric pressure. Consider double isolation (double block and bleed) and the locking or labelling of closed valves. Do not assume that the system has depressurised even when the pressure gauge indicates zero.

1.8 Temperature

Allow time for temperature to normalise after isolation to avoid danger of burns.

1.9 Tools and consumables

Before starting work ensure that you have suitable tools and/or consumables available. Use only genuine GESTRA replacement parts.

1.10 Protective clothing

Consider whether you and/or others in the vicinity require any protective clothing to protect against the hazards of, for example, chemicals, high/low temperature, radiation, noise, falling objects, and dangers to eyes and face.

1.11 Permits to work

All work must be carried out or be supervised by a suitably competent person.

Installation and operating personnel should be trained in the correct use of the product according to the Installation and Maintenance Instructions.

Where a formal 'permit to work' system is in force it must be complied with. Where there is no such system, it is recommended that a responsible person should know what work is going on and, where necessary, arrange to have an assistant whose primary responsibility is safety.

Post 'warning notices' if necessary.

Handling

Manual handling of large and/or heavy products may present a risk of injury. Lifting, pushing, pulling, carrying or supporting a load by bodily force can cause injury particularly to the back. You are advised to assess the risks taking into account the task, the individual, the load and the working environment and use the appropriate handling method depending on the circumstances of the work being done.

1.12

Residual hazards

In normal use the external surface of the product may be very hot. If used at the maximum permitted operating conditions the surface temperature of some products may reach temperatures of 90 °C (194 °F).

Many products are not self-draining. Take due care when dismantling or removing the product from an installation (refer to 'Maintenance instructions').

1.13

Freezing

Provision must be made to protect products which are not self-draining against frost damage in environments where they may be exposed to temperatures below freezing point.

1.14

Disposal

Unless otherwise stated in the Installation and Maintenance Instructions, this product is recyclable and no ecological hazard is anticipated with its disposal providing due care is taken.

1.15

Returning products

Customers and stockists are reminded that under EC Health, Safety and Environment Law, when returning products to GESTRA they must provide information on any hazards and the precautions to be taken due to contamination residues or mechanical damage which may present a health, safety or environmental risk. This information must be provided in writing including Health and Safety data sheets relating to any substances identified as hazardous or potentially hazardous.

1.16

2 General product information

2.1 General description

The MPC range of (self-relieving) high efficiency oil removing filter/regulators provide very high quality compressed air, with accurate pressure control, for pneumatic actuators and general purpose systems.

How efficient is the MPC product range?

The MPC coalescing filters when tested to BS 3928 or the D.O.P. test, are more than 99.99% efficient. In the sodium flame test (BS 3928) the element is challenged by a cloud of salt particles of mass mean diameter of 0.6 micron. In the American D.O.P. test, a cloud of droplets of mass mean diameter 0.3 micron is used.

Available types supplied as standard

MPC1 Metal bowl with manual drain and tamper-proof cap.

MPC2 Polycarbonate bowl with manual drain.











MPC2A Metal bowl with autodrain.

MPC optional extras - Selection table

S = Supplied as standard

OE = optional extra

 = not available

Feature		MPC1	MPC2	MPC2A
Polycarbonate bowl	Without drain		OE	
	With manual drain		S	
Bowl guard			OE	
Metal bowl (no sight glass)	With manual drain	S	OE	
	With autodrain			S
Tamper-proof cap	With locking seal	S	OE	OE
Pressure gauge	50 mm Ø		OE	OE
	40 mm Ø	S	OE	OE
Type 8 mounting bracket			OE	OE
FK21 fixing kit		S	OE	OE
Aluminium locking ring		S	OE	OE

Note: Airsets consist of an MPC with a 40 mm Ø pressure gauge, locking seal and FK21 fixing kit. A tamper-proof cap with locking seal is recommended as an optional extra for MPC2 and MPC2A airsets.

2.2 Sizes and pipe connections

¼" screwed BSP (BS 21-Rp, ISO 7)

Operating pressure ranges

All regulators can be adjusted to zero pressure, or above the figures shown. The operating range is marked on the unit:

0.2 - 2.0 bar g (White)	0.3 - 4.0 bar g (Pink)	0.7 - 9.0 bar g (Black)
-------------------------	------------------------	-------------------------

2.3

Operating limits

Maximum pressure/ temperature	Polycarbonate bowl	10 bar g @ 50 °C	(145 psi g @ 122 °F)
	Metal bowl	17 bar g @ 80 °C	(246.5 psi g @ 176 °F)

2.4

Materials

Part	Material
Body	Aluminium - anodised finish
Plastic bowl	Polycarbonate or aluminium alloy
Bonnet assembly	Polycarbonate or aluminium
Filter element	Microfibre/stainless steel
Valve	Nitrile

2.5

MPC2
shown with optional pressure gauge

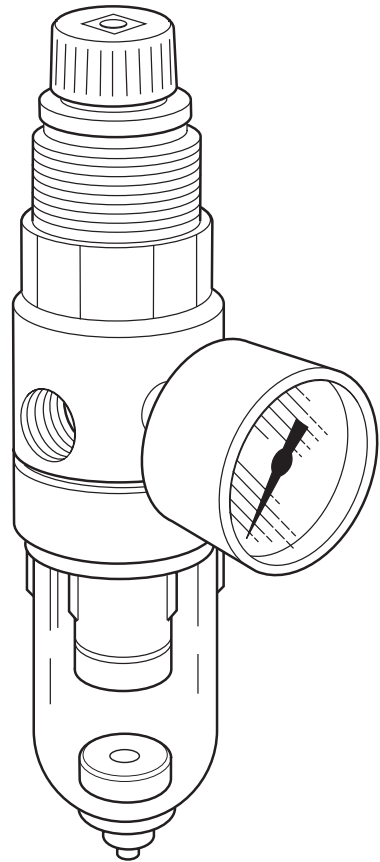

Fig. 1 MPC2 high efficiency compressed air filter/regulator

3 Installation and commissioning

Note: Before actioning any installation observe the 'Safety information' in Section 1.

Referring to the Installation and Maintenance Instructions, name-plate and Technical Information Sheet, check that the product is suitable for the intended installation.

3.1 Specific product safety information

Polycarbonate bowls may be attacked by phosphate ester based fluids, solvents, chemical cleaners, carbon tetrachloride, etc. These and any other substances should not be allowed to come into contact with this component. Certain compressor lubricating oils also contain additives harmful to polycarbonate. Where there is any doubt we recommend, in the interests of personal safety, that bowl guards or metal bowls be fitted.

3.2 General information

Dimensions (approximate) in millimetres

Type 8 mounting bracket (Fig. 2) and mounting ring for general installations

The filter/regulator can be mounted using this zinc plated mild steel bracket and aluminium mounting ring. Both items are optional extras and must be specified when placing an order.

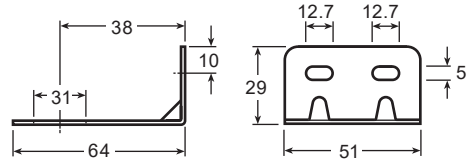

FK21 fixing kit (Fig. 3)

The FK21 fixing kit is required to mount the MPC2 onto the GESTRA range of PN pneumatic actuators. The fixing kit and aluminium mounting ring are optional extras and must also be specified when placing an order.

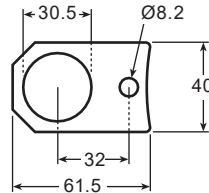

MPC2 The MPC2 high efficiency compressed air filter/regulator (Fig. 4)

Dimensions/weight (approximate) in mm and kg

Unit	Size	A	B	C	E	E1	Weight
MPC1	¼"	75	167	41	25	-	0.2
MPC2	¼"	65	155	41	25	45	0.2
MPC2A	¼"	75	167	41	25	-	0.2

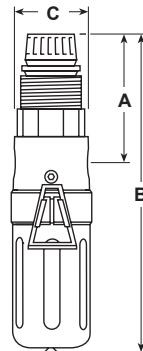

Withdrawal distance: E without bowl guard
E1 with bowl guard

Installation

- 3.3.1** The unit should be fitted in horizontal pipework with the bowl vertically downwards.
- 3.3.2** Adequate space should be provided around the unit to allow easy access for routine servicing requirements (see Figure 4 for withdrawal distances).
- 3.3.3** Connect the unit so that the airflow is in the direction indicated by the arrow on the body.
- 3.3.4** The unit should be installed as close as possible to the equipment it is serving.
- 3.3.5** The body has two R $\frac{1}{8}$ " ports, one of which is available for fitting a pressure gauge to register the secondary pressure. In the event that a pressure gauge is not fitted, this port should be blanked off with the blank plug provided. Ensure that the range of the pressure gauge corresponds with that of the main control spring as indicated on the unit. The second port should not be used for any purpose and is sealed with a factory fitted plug which should not be removed.
- 3.3.6** Do not overload the filter cartridge (see Section 4 - Operation) or there will be a reduction in its efficiency and/or life. On heavily contaminated systems, it is advisable to fit a conventional pneumatic filter (International or Miniature) immediately in front of the unit for maximum efficiency and life cycle.
- 3.3.7** The polycarbonate bowl may be fitted with a bowl guard, or replaced with a metal bowl.

Adjustment

- If a locking seal (18) is fitted, remove it to readjust the set pressure to the required value.
- Lift the locking ring (11).
- Turn the adjustment knob (10) clockwise to increase the pressure.
- Depress the locking ring (11) to lock.

Note: A metal tamper-proof cap (an optional extra) may be fitted over the adjustment housing. It is recommended that all adjustments be made under flowing conditions. There will be a slight increase in set pressure when the flow stops.

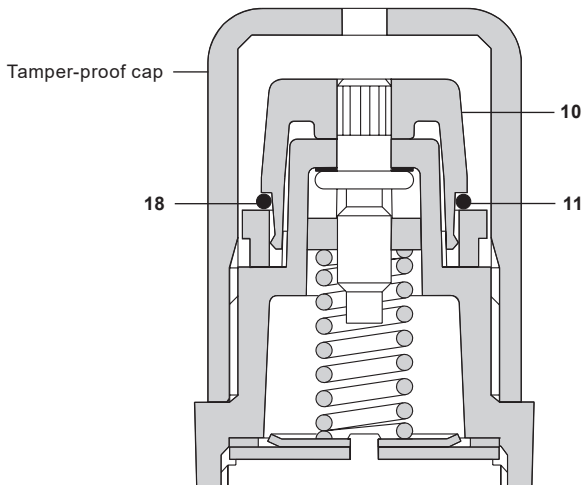

Fig. 5 Adjustment

4 Operation

4.1 Operating principals

These units filter out solid contaminants and remove oil and water liquids and aerosols, by coalescing. Contaminated air flows to the inside of the filter cartridge. The cartridge contains a labyrinth of micro fibres which will trap solid particles down to sub micron size. Fine liquid mist and aerosols on their journey through the depth of the element, will strike one or other of the fibres and will be retained on them by inter-molecular forces.

As the droplets migrate through the element due to the air flow, they will join (coalesce) with others, growing in size. A specially designed porous plastic sock forms the outer layer of the filter cartridge. This encourages further coalescing, so that the droplet mass is sufficient to allow it to gravitate to the sump of the filter from which they can be drained manually. The porous plastic sock also reduces the possibility of re-entrainment.

With the adjustment knob (10) rotated fully anticlockwise, the valve return spring (17) will keep the main valve (12) shut. Clockwise rotation of the adjustment knob will compress the main control spring (15), deflect the diaphragm assembly (14) downwards, opening the main valve (12). As air flows to the downstream (13) side of the filter/regulator, the secondary pressure increases. The secondary pressure is sensed on the underside of the diaphragm. As the controlled pressure varies, so does the force on the underside of the diaphragm. When this force (proportional to the secondary pressure) equals the compression in the main control spring, the main valve will shut. Any fall in the secondary pressure will cause the main valve to open sufficiently to meet the air flow requirements and maintain the set secondary pressure.

Any appreciable rise in the secondary pressure from its set value will cause the diaphragm and the pushrod (16) to lift. This will allow air to escape through the centre of the push rod to atmosphere. When excess pressure has vented, the orifice in the pushrod will reseal on the main valve.

Ensure that the bowl is regularly drained by means of the quick action drain valve (9).

Do not exceed the maximum flowrate (for any given pressure) as shown in Section 4.3 or there is every chance that some of the coalesced liquids will be re-entrained and carried on downstream.

4.2 Performance selection (with primary pressure 10 bar)

For any specified primary filtration pressure, there is a maximum recommended air flowrate. Keeping within this, will ensure that the element performance maintains the stated high efficiency levels, particularly for the removal of oil and water contaminants.

4.3 Maximum secondary flow at peak performance

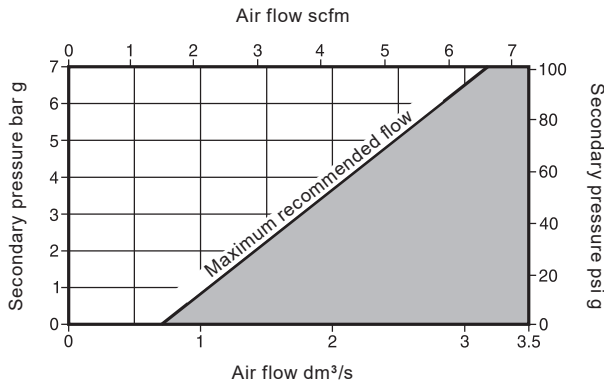

Use of the product in this region may reduce the oil removing efficiency.

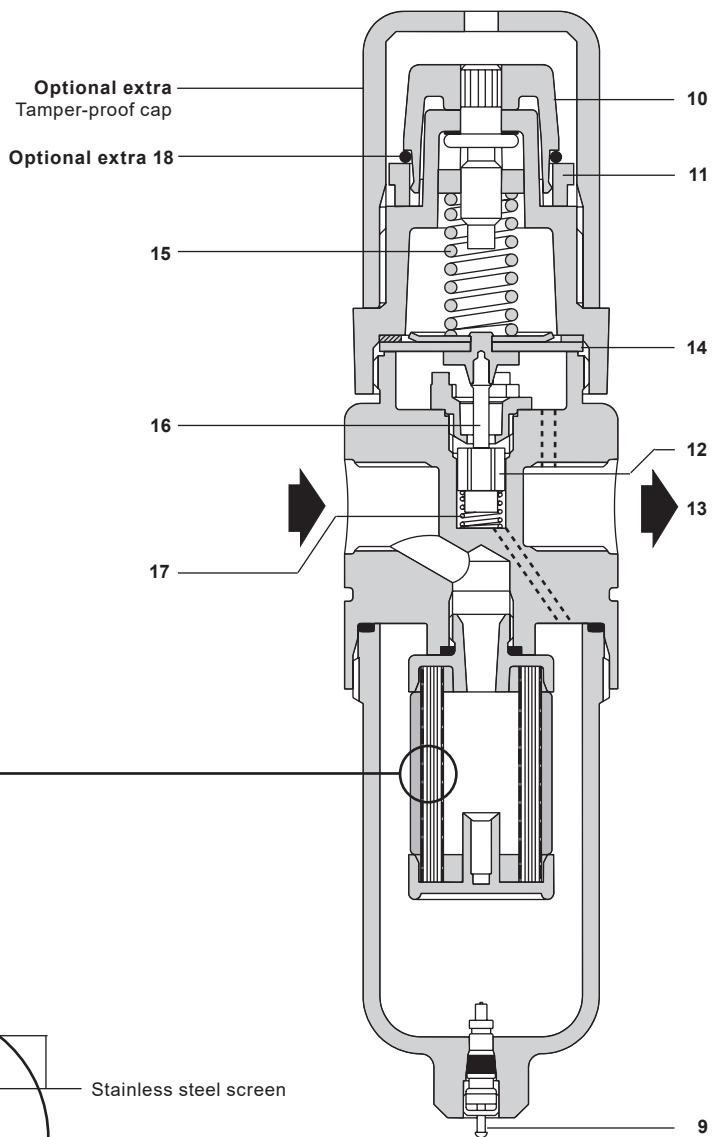
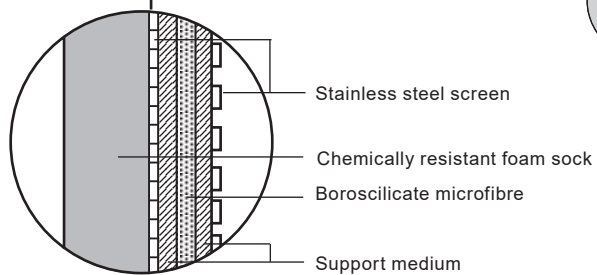

Fig. 6 Operation



5 Spare parts and maintenance

5.1 Spare parts

The spare parts available are detailed below. No other parts are supplied as spares.

Available spares

Polycarbonate bowl, Metal bowl, Drain assembly (specify with or without drain)	1, 2
Element and 'O' ring set	2, 3, 4
Bowl guard assembly (MPC2 only)	5, 6, 7

Note: In the interests of safety GESTRA recommend that a bowl guard (an optional extra) should be fitted to polycarbonate bowls.

How to order spares

Always order spares by using the description given in the column headed 'Available spares' and state the size and type of unit.

Example: 1 - Element and 'O' ring set for a MPC2 high efficiency compressed air filter/regulator.

5.2 Maintenance

To service the filter (no tools required):

- Isolate the main air supply.
- Release the pressure by turning the main control knob (8) fully anticlockwise, remove the bowl guard if fitted and depress the drain valve (9).
- Remove the bowl (1) and unscrew the filter element assembly (2, 3 and 4).
- Clean the bowl using soap and water and dry with a lint free cloth.
- Reassemble in reverse order, ensuring that the element 'O' ring (4) is fitted.
- The bowl should be firmly hand tightened.

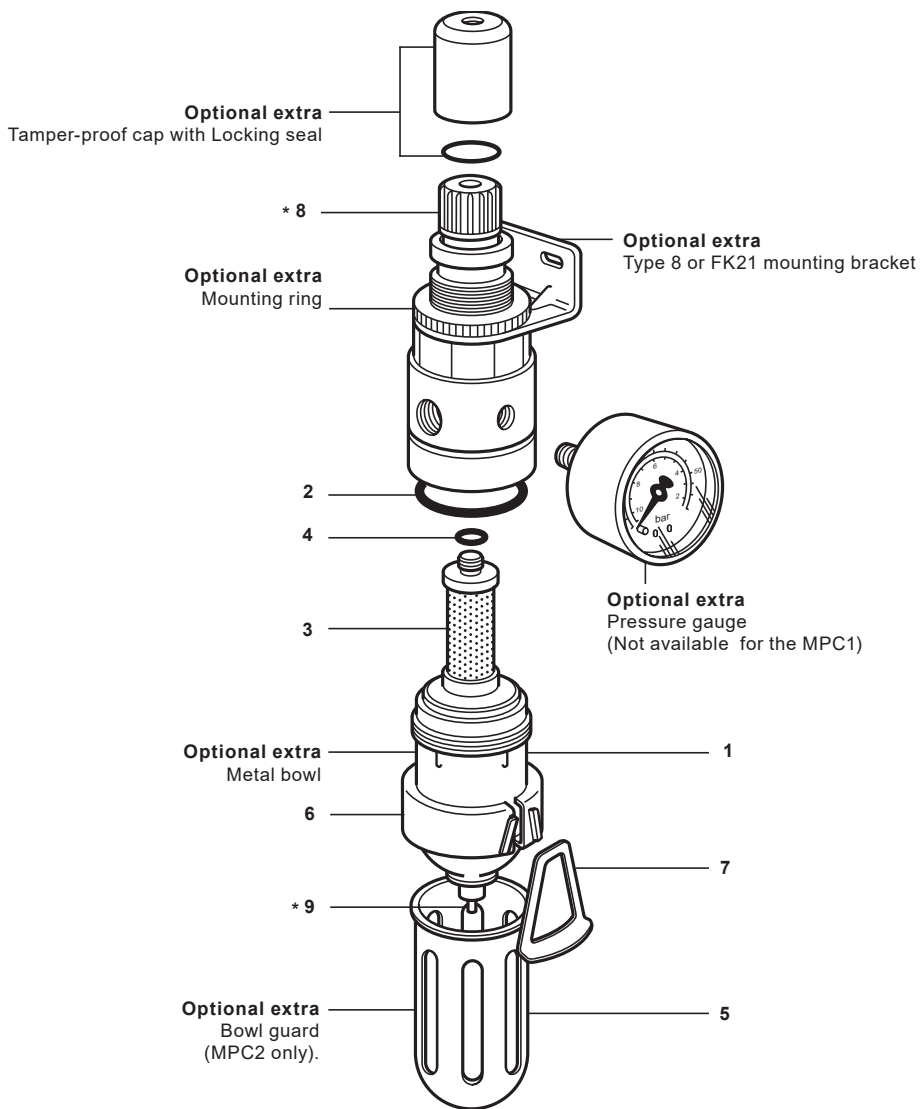

* **Note:** Not available as spares.

Fig. 7 Spares and optional extras



Agencies all over the world: www.gestra.com

GESTRA AG

Münchener Straße 77

28215 Bremen

Deutschland

Telefon +49 421 3503-0

Telefax +49 421 3503-393

E-mail info@de.gestra.com

Web www.gestra.com