



Control, Display & Operating Panel

SPECTOR*control II*

EN
English

Original Installation & Operating Manual
819410-03

Contents

Page

Important notes

About this Installation & Operating Manual	4
Additional documents.....	4
Usage for the intended purpose.....	4
IT security and rules for the use of Ethernet devices.....	4
Definition of terms.....	4
Function.....	7
Safety note.....	7

Directives and standards

UL/cUL (CSA) Approval	8
Applicable directives and standards	8
Notes on the Declaration of Conformity/Manufacturer's Declaration CE	8
Notes on product liability.....	8

Technical data

SPECTOR <i>control</i> II control, display and operating panel	9
--	---

In the control cabinet: Installing the SPECTOR*control*

SPECTOR <i>control</i> dimensions	10
Installation in control cabinet.....	11

In the control cabinet: Connecting the SPECTOR*control*

SPECTOR <i>control</i> wiring diagram.....	12
Key	12
Supply voltage connection.....	13
Connecting the power supply of the SPECTOR <i>control</i>	13
WAGO I/O system 750 supply voltage.....	14
Assignment of the COM1 port for burner control: Modbus	14
CAN interface assignment	15
Ethernet connection	16
Assignment of Profibus (optional).....	16

Factory setting

SPECTOR <i>control</i>	17
------------------------------	----

Bringing into service

Switching on the supply voltage	17
Home screens	18

Operating the SPECTOR*control*

Meaning of the most common buttons	19
Menu structure	20

System malfunctions

Indications, diagnosis and remedies	24
Action against high-frequency interference	25
Display of system malfunctions in the alarm and error list using fault codes.....	26-28
Disposal	29
Taking out of service	29

Important notes

About this Installation & Operating Manual

This Installation & Operating Manual is a short instruction booklet containing important information on function, installation, electrical connection and bringing into service.

Additional documents

The equipment specification EP - 3xx (SPECTOR*control*) is part of this Installation & Operating Manual. This description is stored in the equipment along with other documents.

Usage for the intended purpose

The SPECTOR*control* is used for controlling, viewing and setting parameters of GESTRA CANopen devices. In combination with SPECTOR*connect* devices, it is used for visual display and status analysis with a gateway functionality.

As well as GESTRA CANopen devices, it can also be connected to equipment from other manufacturers, if approved by GESTRA, and integrated in the plant system.

IT security and rules for the use of Ethernet devices

The plant operator is responsible for the security of his/her IT network and must take appropriate action to protect equipment, systems and components from unauthorised access.

Pay attention to the following instructions when using Ethernet devices in your system:

- Do not connect equipment, systems or components to an open network such as the internet without adequate protection.
- To fully protect a PLC runtime system on a control system that is accessible via the internet, the use of common security mechanisms such as firewalls and VPN access is absolutely essential.
- Restrict access to all components to authorised persons only.
- Always change default factory-set passwords before bringing into service for the first time!
- Deploy defence in depth mechanisms in your plant security, to restrict access and control to individual products and networks.

Definition of terms

3-component controller

Large, temporary spikes in steam consumption cause the water in the pressurised system to boil and effervesce, resulting in abnormally high readings by the level electrode.

To correct this error, both the water level and the steam and feedwater flowrate are measured, and the difference is used to determine an appropriate quality factor. This factor allows you to assess the impact of this difference (steam flowrate - feedwater flowrate) on the measured level signal.

Creep flow

Creep flow means that low flowrates are not measured during flowrate measurement. Creep flow is caused by convection when the valve is closed.

Definition of terms continued

Cutout threshold

If the control point is below the cutout threshold during pump control, the control point = 0. This prevents the pump from constantly switching on and off.

Continuous blowdown

As the boiler water begins to evaporate, the concentration of non-volatile total dissolved solids (TDS) left behind in the boiler increases over time as a function of steam consumption. If the TDS concentration exceeds the limit defined by the boiler manufacturer, foaming and priming occurs as the density of the boiler water increases, resulting in a carry-over of solids with vapour into steam lines and superheaters.

The consequences are adverse effects on reliability and severe damage to steam generating units and pipes. To keep the TDS concentration within admissible limits, a certain portion of boiler water must be removed continuously or periodically (by means of a continuous blowdown valve) and fresh feedwater must be added to the boiler feed to compensate for the water lost through blowdown.

To determine the TDS in the boiler water, its electrical conductivity is measured in $\mu\text{S}/\text{cm}$, although some countries also use ppm (parts per million) as the unit of measurement.

Conversion $1 \mu\text{S}/\text{cm} = 0.5 \text{ ppm}$.

Intermittent boiler blowdown

During the evaporation process, fine sludge is deposited on heating surfaces and on the floor of the steam generating unit. This sludge is caused by adding oxygen-scavenging agents, for example. As the sludge prevents the transfer of heat, the boiler walls can become dangerously overheated.

Intermittent blowdown is achieved by the abrupt opening of the intermittent blowdown valve.

The resulting suction effect occurs only at the moment the valve is first opened. The opening time should therefore not exceed about 3 seconds. Longer opening times result in a loss of water.

Time-based pulse/interval actuation of the intermittent blowdown valve optimises the removal of sludge from the boiler. The interval between intermittent blowdown pulses can be set, as can the blowdown time.

For large boilers, repeated intermittent blowdown pulses may be required. In this mode, you can then set the repetition and interval between pulses.

Operating position of the continuous blowdown valve

To keep the TDS within the desired limits, it is common practice for the continuous blowdown valve to remove a certain amount of water from the boiler. This means that the valve must be permanently open during operation, so that this amount of water can be discharged (valve in operating position).

This operating position can be adjusted accordingly. For the corresponding amount of boiler blowdown, refer to the capacity charts of the continuous blowdown valve.

Compensation for steam bubbles (conductivity control)

The presence of steam bubbles can lead to greatly fluctuating conductivity readings. An attenuator will damp the oscillations in the measurements.

Switching hysteresis (conductivity control)

If the controller is configured as 2-position controller, the valve will OPEN if there is a positive deviation ($X > w$). The conductivity must then decrease until it reaches a new valve that is lower than the setpoint minus the adjusted hysteresis. After this, the valve is moved into the Closed or Operating position, depending on your settings.

Definition of terms continued

Standby mode (conductivity control)

To prevent water losses, continuous blowdown control and automated intermittent blowdown (if enabled) can be disabled in standby mode or when the burner is switched off. The continuous blowdown valve moves to CLOSED position, triggered by an external control command. The MIN/MAX limits and monitoring function remain active in standby mode.

After the equipment has switched back to normal operation, the continuous blowdown valve is moved into the OPERATING or control position. In addition, an intermittent blowdown pulse is triggered, based on your settings.

Temperature compensation (conductivity control)

The electrical conductivity of water changes as the temperature falls or rises. To obtain meaningful readings, it is therefore necessary to base the measurements on the reference temperature of 25°C, and to correct the measured conductivity using a temperature coefficient.

Switching is no longer possible in the SPECTOR*connect*, TK Linear is the only option.

TK (Linear)

To ensure the reading is based on 25 °C, set the TK between 0 and 3.0 % per °C (the default is 2.1 % per °C). This ensures linear temperature compensation of the reading over the entire measuring range. This method is usually applied for steam generating units operating at a constant service pressure. When the TK is set and the service pressure has been reached, use a calibrated conductivity meter to measure the conductivity of the boiler water, and compare the reading with the indicated conductivity value. If the reading differs from the indicated conductivity, change the TK setting until they tally.

TK (standard)

Since the relationship between conductivity and temperature is not linear over a larger temperature range, various conditioning agents and different basic conductivities were used to establish empirical conductivity/temperature curves. These curves are stored as standard curves and can be used for temperature compensation. TK (STANDARD) is suitable for steam generating units operating with variable pressure, i.e. that do not have a fixed working pressure (e.g. low load 10 bar, full load 15 bar).

TK (AUTO)

With this method, a plotted, installation-specific conductivity/ temperature curve is used for temperature compensation. This curve is plotted during the heating process and stored as an Auto curve. The TK (AUTO) method is particularly suitable for steam generating units operating with variable pressure.

Cell constant and correction factor (conductivity control)

The geometric variable (cell constant) of the conductivity electrode is taken into account when calculating the conductivity. However, this constant may change during operation, e.g. due to soiling of the measuring electrode. Deviations can be corrected by changing the correction factor. If the correction factor is too high, a warning is displayed and the electrode must be cleaned.

Flushing the continuous blowdown valve

The continuous blowdown valve can be flushed automatically to prevent it from sticking. For this, the continuous blowdown valve is actuated at intervals and opened for a certain time. After the flushing time, the valve is moved into the OPERATING position or into the required control position.

Function

The SPECTOR*control* (SC) is a control, display and operating panel with integrated programmable logic controller (PLC) for CANopen devices.

In addition to GESTRA equipment such as conductive and capacitance level electrodes, temperature limiters and conductivity electrodes, you can also connect equipment from other manufacturers, such as Jumo CANTransP/T, and incorporate it in the overall system.

Data are exchanged between CANopen devices and the SPECTOR*control* via the ISO 11898 CAN bus using the CANopen protocol.

The SPECTOR*control* periodically determines the current parameter settings and values of the CANopen devices. These are available for viewing as soon as the associated node ID has been set or allocated. After this, connected equipment can be set and allocated directly on the SPECTOR*control*.

The individual inputs can be flexibly allocated to the various CAN nodes. However, the allocation of the I/O module is dictated by the selected layout and cannot be changed. After a restart, the equipment is in the initializing phase for approx. 10 seconds. After this, it shows up-to-the-minute readings of the CAN nodes.

The system can process digital signals and analogue values, and allows you to establish alarm and switching limits for them. These signals can be switched directly on the controller or further processed by the logic and calculation functions, for example. Next, the signals are transmitted once again via a digital or analogue output (IPO model). These signals can be used to accomplish various switching tasks.

Clear, unambiguous signal names allow them to be allocated quickly in the system. Any cryptic designations can be replaced by the name of the equipment or the place of installation, for example, "LRG 16-41" can become "Boiler feedwater conductivity". The maximum number of characters is 30. This name is then used universally as key identifier. This is advantageous in large installations, where not only boiler data but also liquid levels in feedwater and condensate tanks are recorded.

Safety note

The equipment may only be installed and brought into service by qualified and competent staff. Retrofitting and maintenance work may only be performed by authorised staff who have achieved a recognised level of competence through specific training.

The equipment specification EP - 3xx (SPECTOR*control*) is part of this Installation & Operating Manual. This description is stored in the equipment along with other documents.

Please pay attention to the safety notes in these documents!

Important notes continued



Danger

The SPECTOR*control* is **not** a substitute for the control units for the low-level (LW) limiter and high-level (HW) alarm or the safety temperature limiter (STL). It is used solely for indicating these states.

This also applies to the URS 60 and URS 61 in conjunction with SPECTOR*connect* devices. Data can only be exchanged safely with equipment tested and approved by GESTRA.

Directives and standards

UL/cUL (CSA) Approval

The equipment conforms to standards: UL 60950-1 and CSA C22.2 No. 60950-1, Information Technology Equipment - Safety - Part 1: General Requirements. File E176557.

Applicable directives and standards

The SPECTOR*control* II has been tested and approved for use in the scope governed by the following directives and standards:

Directives:

- 2014/30/EU (EMV Directive)
- 2014/34/EU (ATEX Directive)
- 2011/65/EU (RoHS Directive)

Standards:

- EN IEC 63000
- EN 60079-0
- EN 60079-31
- EN 61000-6-2
- EN 61000-6-4

Notes on the Declaration of Conformity/Manufacturer's Declaration CE

The Declaration of Conformity of the Grossenbacher EP-380 remains valid.

Notes on product liability

We the manufacturer cannot accept any liability for damages resulting from improper use of the equipment.

Technical data

SPECTOR*control* II control, display and operating panel (EP-380)

- 10.4" VGA IR TFT touchscreen
- 3 x Ethernet 100/1000 Mbps RJ45 (intranet/Modbus TCP/IP/OPC UA, EtherCat)
- CAN interface
- Modbus RTU RS232 for specific burner connection
- micro SD card slot ensuring data remanence for data logging
- USB ports for importing and exporting data
- Profibus DPS (optional)
- Supply voltage 24 V DC (+/- 20%)
- Max. power consumption 17 W
- IP rating of front IP 65
- Front panel cutout 329 x 230 mm
- Front dimensions 345 x 260 mm
- Service temperature 0..50°C when installed vertically
- Climate 10..90% rel. humidity

In the control cabinet: Installing the SPECTORcontrol

SPECTORcontrol dimensions

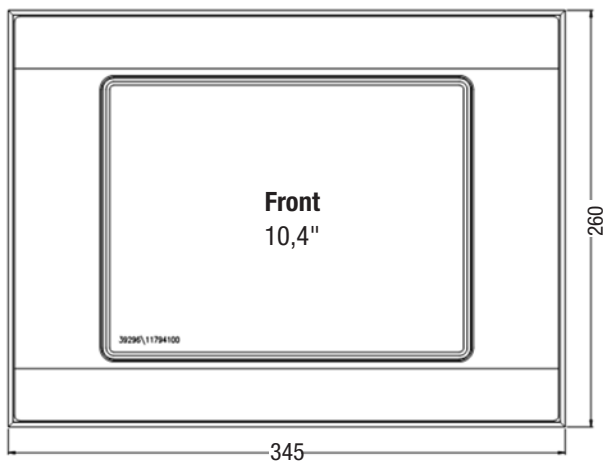

Fig. 1

Back

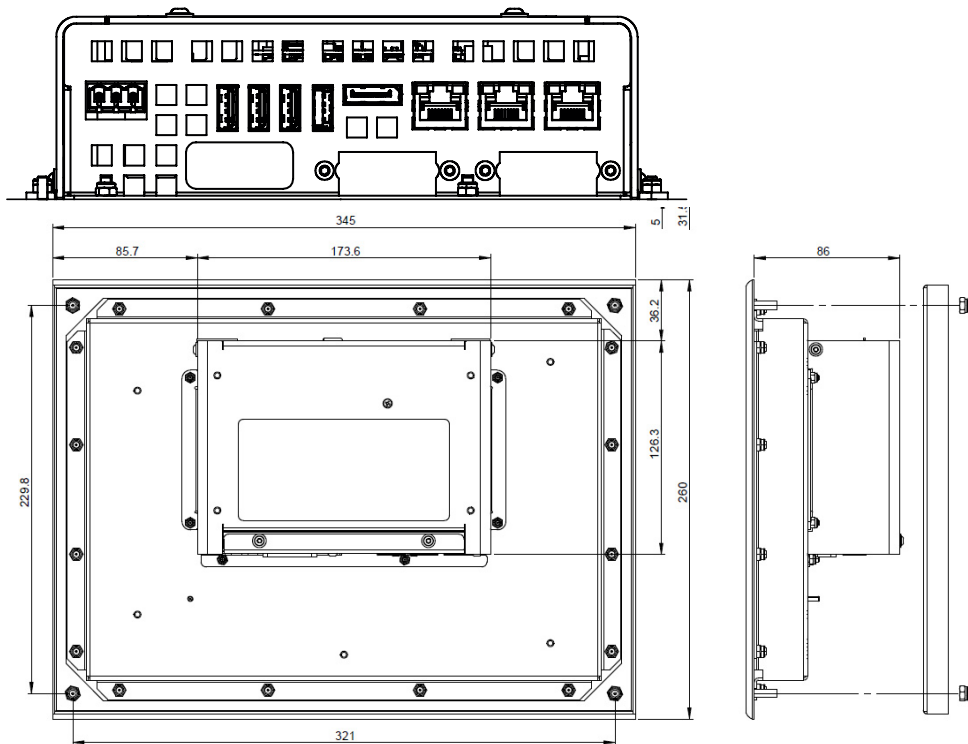

Fig. 2

SPECTORcontrol dimensions continued

Front panel cutout

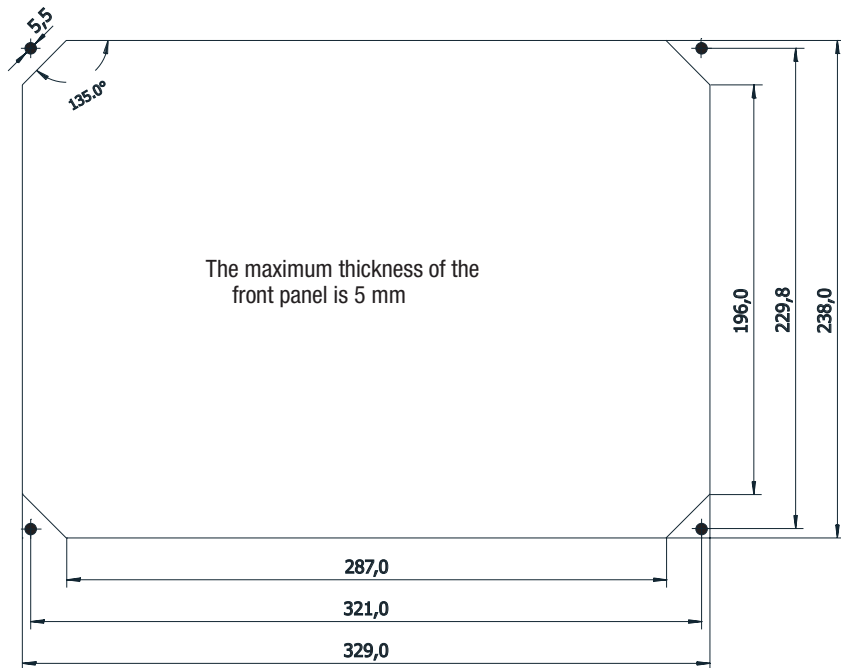

Fig. 3

Installation in control cabinet

The SPECTORcontrol is installed in the door of the control cabinet. It is fastened from the rear using the integrated threaded pins. The SPECTORcontrol can be operated up to a max. ambient temperature of 50 °C. Please note that direct sunlight (UV light) reduces the service life of the liquid crystals. Install the SPECTORcontrol as follows:

- Unscrew the lock nuts and take off the mounting frame.
- Insert the supplied seal in the groove in the front frame.
- Push the SPECTORcontrol from the front into the front panel cutout.
- Push the mounting frame back onto the threaded pins. Screw the unit onto the mounting frame using the four lock nuts, making sure they are tightened evenly. Stop tightening when the front frame is flush with the front panel all the way round.

In the control cabinet: Installing the SPECTORcontrol continued



Attention

- Avoid locations where direct sunlight falls onto the screen.
- The mounting angle must not exceed $\pm 35^\circ$ from the vertical.
- Make sure the seal is seated correctly on the front panel. On units with a round seal, the two ends of the seal must meet at the bottom of the unit without a gap.
- Avoid tightening torques greater than 0.5 Nm as this could damage the equipment.
- The front panel may have a maximum thickness of 5 mm

In the control cabinet: Connecting the SPECTORcontrol

SPECTORcontrol wiring diagram

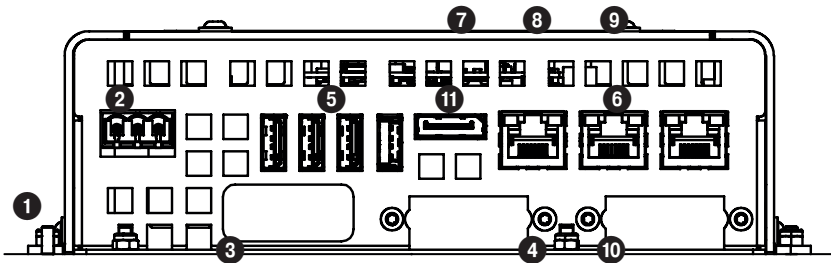

Fig. 4

Key

- | | |
|-----------------------------|--|
| ① Functional earth terminal | ⑥ 3 x Ethernet |
| ② Power supply | ⑦ micro SD card slot |
| ③ COM1 | ⑧ Battery |
| ④ CAN | ⑨ Cfast slot |
| ⑤ 3 x USB 2.0, 1 x USB 3.0 | ⑩ Slots for mPCIe option (see nameplate) |
| ⑪ Display port connection | |

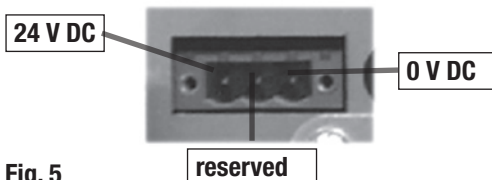

Fig. 5

Supply voltage connection

The SPECTOR*control* unit, CANopen devices and WAGO I/O module are supplied with 24 V DC / ≥ 5 A. 5 A is the sum current of all CAN bus nodes. Please use a safety power supply unit with reliable electrical isolation.

This power supply unit must be electrically isolated from dangerous live voltages and meet the requirements for double or reinforced insulation in accordance with one of the following standards: DIN EN 50178, DIN EN 61010-1, DIN EN 60730-1 or DIN EN 60950.



Attention

- Do not use the bus power supply for GESTRA SPECTOR*bus* control units for supplying power to the SPECTOR*control* or connected equipment.

Connecting the power supply of the SPECTOR*control*

The SPECTOR*control* belongs to protection class 3. The unit is supplied with 24 V DC SELV (Safety Extra Low Voltage). Remember to take the maximum breaking capacity of the fuse into consideration. The power supply is not galvanically isolated. The 0V connection is directly at the housing potential. Produce the connection as follows:

- The supply cable must have a cross-section of 0.75 mm² minimum and 2.5 mm² maximum.
- A flexible lead or wire can be used for connection.
- Remember to take the power consumption into consideration.
- The use of a functional earth can prevent interference due to differences in potential. The cross-section must not exceed 2.5 mm².
- The GND is connected directly to the housing potential.

The connector (female header with screw terminals) for connection is included in the product package (WAGO 1757022).



Attention

- In the event of reverse polarity and simultaneous connection of another 0V connection, e.g. GND of the COM1 port, the fault current flows via this 0V connection. If the housing is also not connected to the 0V potential, the Ethernet panel or external components may suffer irreparable damage!
- For a safe connection, make sure the two connecting cables are joined close to the connector.



WAGO I/O system 750 supply voltage

If you use a WAGO module for SPECTORcontrol note that the sum current of the internal power consumption must not exceed the sum current of the bus modules.

If necessary position a potential feed terminal with bus power supply unit (750-613) upstream of the module where the admissible sum current was exceeded.

Example:

In a node with a CAN bus coupler 750-337, 10 relay terminals (750-513) should be used. The power consumption for this is $18 \times 100 \text{ mA} = 1800 \text{ mA}$. The coupler can provide 1650 mA for the bus modules. Consequently, a potential feed terminal with bus power supply unit (750-613, max. 2 A output current) must be added from the eighth terminal 750-513 of the node. In cases like this, a warning will tell you of this situation when you are setting the parameters for the terminal.

You can check the configurations of the WAGO module using the free smartDESIGNER planning tool.

Assignment of the COM1 port for burner control: Modbus

3

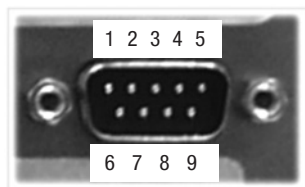

Connector

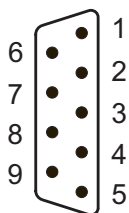

9-pole D-Sub connector

Pin no.	Signal
1	
2	RXD
3	TXD
4	
5	GND
6	
7	
8	
9	

The COM1 serial interface is PC-compatible.



Attention

- Please use a shielded, multi-core data cable for connection.
- Route the data cable to other units separately from power lines.
- Connect the shield of the data cable just once to the central earthing point (CEP) in the control cabinet.

CAN interface assignment 4

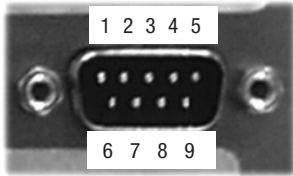

Pin no.	Signal	Description
1	-	-
2	CAN LOW	Negative data signal
3	GND	Signal ground
4	-	
5	-	
6	GND	Signal ground
7	CAN HIGH	Positive data signal
8	-	
9	-	
Housing	Case	Cable shield

CANopen devices are connected via the CAN interface.

Use a cable with D-subminiature connector (to DIN 41652) as the data cable.

Use a shielded, multi-core, twisted-pair control cable, e.g. UNITRONIC® BUS CAN 2 x 2 x .. mm² or RE-2YCYV-fl 2 x 2 x .. mm², as the bus line.

Cable length	Number of pairs and wire cross-section [mm ²]
125 m	2 x 2 x 0.34
250 m	2 x 2 x 0.5
335 m	2 x 2 x 0.75
Other lengths available on request	



Note

The type and preparation of the data cable have a considerable influence on the electromagnetic compatibility (EMC) of the SPECTORcontrol. Therefore, take special care during connection.

- Make sure wiring is in line, not in a star!
- Route the data cable separately from power lines.
- Use a central earth to prevent differences in potential between system parts.
- Connect the bus cable shields such as to ensure electrical continuity, and connect to the central earthing point (CEP).
- If two or more system components are connected in a CAN bus network, install a 120 Ω terminating resistor (CAN LOW/CAN HIGH module) to the first and last units.

Ethernet connection 6 + 7

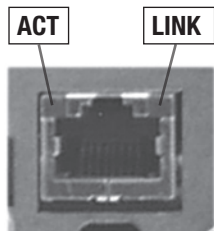

RJ45 connector



8-pole RJ45 socket

Pin no.	Signal
1	TXD
2	TXD+
3	RXD+
4	-
5	-
6	RXD-
7	
8	

The Ethernet interface conforms to the standard IEEE 802.3 (10/100/1000BASE-T).

The network connection is produced using a shielded Cat-5e cable with RJ45 connectors. The maximum cable length and transfer speed are determined by the cable properties defined in EIA/TIA 568 TSB-36. Cable lengths up to 100 m are permitted.

Two diagnostic LEDs are available:

Orange: LINK (connection to hub or another device)
 Green: ACT (send or receive)



Attention

- Please use a shielded, multi-core data cable for connection.
- Route the data cable to other units separately from power lines.
- Connect the shield just once to the central earthing point (CEP) in the control cabinet.

Assignment of Profibus (optional) 10

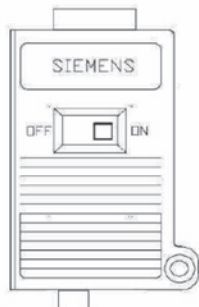
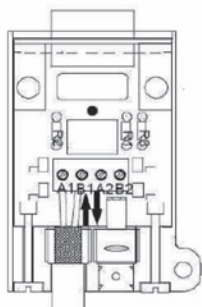

Connector

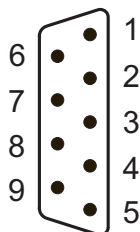

9-pole D-Sub connector

Pin no.	Signal
1	
2	
3	Line B
4	
5	GRD
6	
7	
8	Line A
9	

Factory setting

SPECTOR*control*

All adjustable masks are fully available, regardless of whether or not the indicated instruments are part of the bus system. Subsequent expansion or modification is therefore possible at any time.

The SPECTOR*control* runtime licence can be found on the rear of the unit. If you need to re-enter this licence but the label is no longer on the unit, please request it from Gestra Bremen.

The inputs/outputs of the WAGO I/O module can only be defined after you have entered the number of terminals in [SPECTOR*control*]/System/I/O Module.

The system settings for initial startup are stored on the CompactFlash. Data are also stored on the CF card during operation of the SC, in the /DATA folder.

The equipment features the following default settings:

■ Date/time	Current date and time (daylight saving time: disabled)
■ Home screen	Home screen 1 (1..4 to be defined as desired)
■ Language	German
■ IP address 1 (Ethernet 1)	192.168.0.99
■ IP address 2 (Ethernet 2)	reserved
■ IP address 3 (Ethernet reserved)	can be freely assigned
■ Passwords	Level 1: aaa Level 2: bbb
■ Node ID SC	127
■ Node ID of WAGO I/O	126
■ Baud rate	50 kB
■ Profibus station address	10 (slave), freely adjustable



Note

We recommend using new passwords after initial startup!

Make sure that the same password is not used twice.

The maximum length of the password is 8 characters.

Bringing into service

Switching on the supply voltage

Switch on the supply voltage for the SPECTOR*control*. Home screen 1 opens.



Attention

- Please pay attention to the Installation & Operating Manuals of the connected equipment.

Bringing into service

Home screens

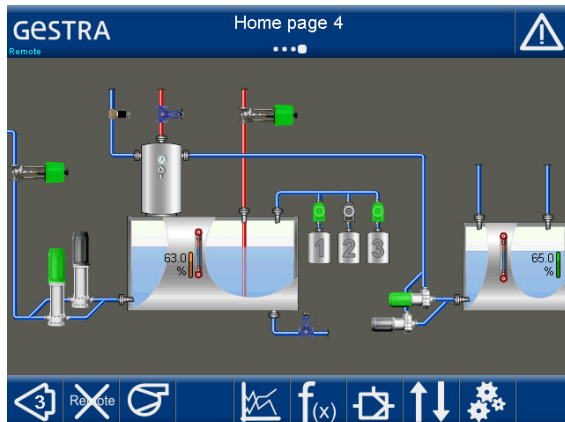
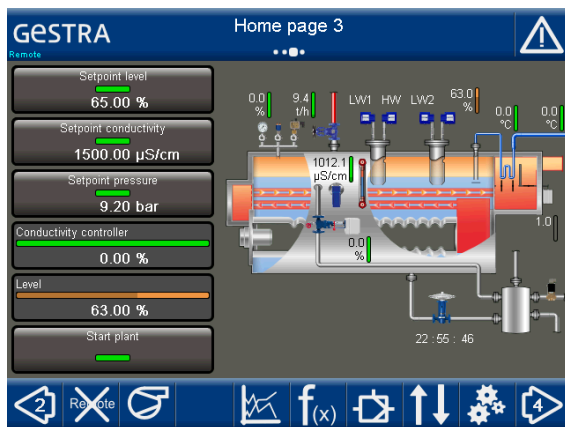
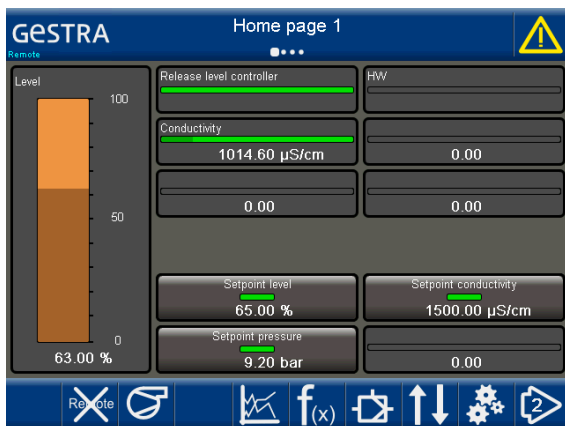







Operating the SPECTOR*control*



Note

Operate the SPECTOR*control* by pressing the on-screen buttons or by swiping.

Meaning of the most common buttons

Button	Meaning
	Home: Press this button to open one of the home screens (1..4). To define the home screen, go to: System/Backlight - Home Screen.../. If you do not enter anything for 60 minutes, the home screen automatically opens.
	Alarm: If there is an alarm, the symbol flashes. Press this button to view the alarm list. If the alarm has gone but has not been reset, the button remains highlighted. To sort the list entries, press the yellow title bar. If you touch a row, the signal name will appear at the bottom.
	Back: Exit or close the page.
	Delete: Delete signals, lists, etc. You will be asked to confirm this first.
	Save: Press this button to save lists (e.g. flowrate or alarm). They are stored on the CF card in the unit in [StorageCard]/Data.
	Setup: Press this button to customise values, signals, pages, etc.
	Displays: Press and hold this button (more than 1 s) to view detailed operating instructions.



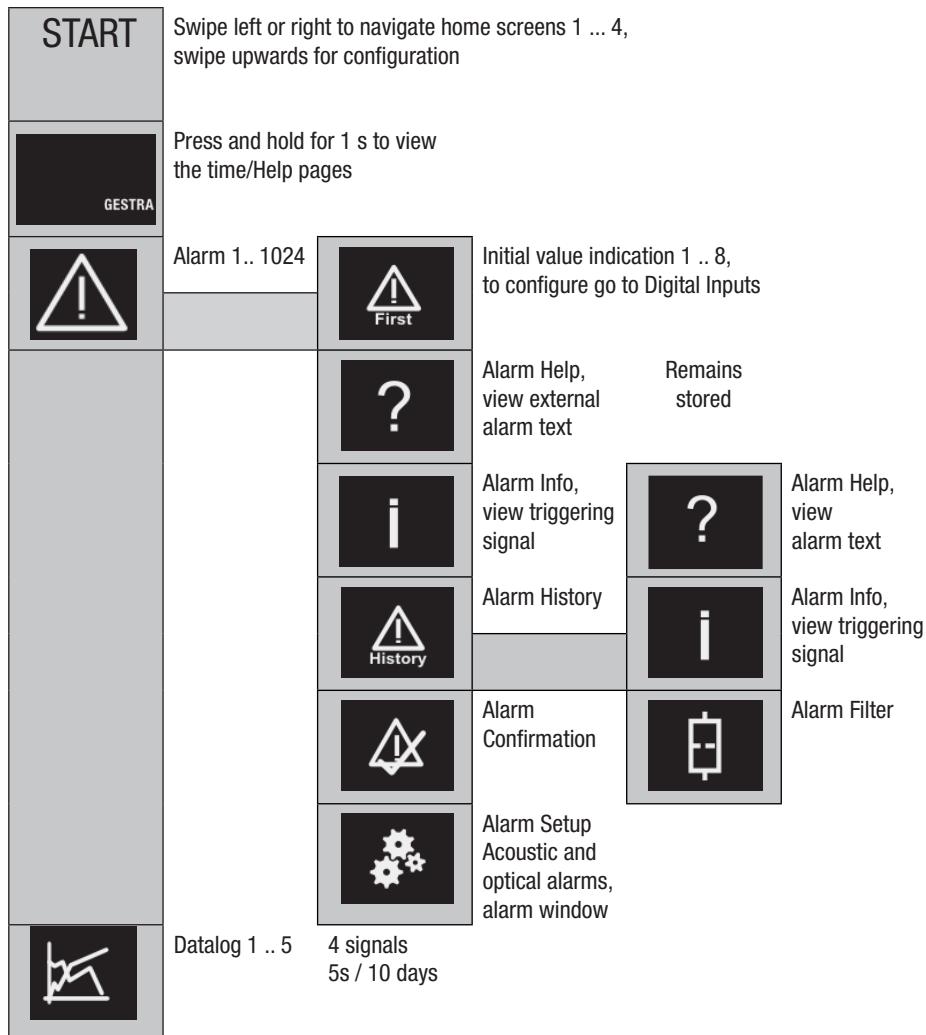







Menu structure







Menu structure continued

	Functions		Flowrate 1 .. 10	Analogue input Steam signal Digital input, etc.
			Steam flow-rate/capacity 1..5	Saturated steam/superheated steam 0 - 500 °C 0 - 50 bar
			Calculation 1 .. 5	e.g. dTemp for controller setpoint
			Logic function 1 .. 20	e.g. for enabling the controller
			Sequencer 1 .. 5	e.g. start up burner based on dT
			Timer 1 .. 5	Week timer
			Maintenance 1 .. 5	Runtime Switching cycles
		Controller 1 .. 12	Continuous controller Continuous pump controller 3-position stepping controller 2-position valve controller 2-position pump controller Intermittent boiler blowdown 3-component continuous controller 3-component stepping controller Dosage controller	External MIN control point (min. pump speed) 3 pumps Dead zone, soft start With lockout function Pulse duration/min. interval

Menu structure continued

	Inputs/outputs		CAN inputs 1 .. 30	URS 60/61 NRG 26-6x LRR 1-60...
			Analogue inputs 1 ..20	4..20 mA PTxxx, thermoelement resistance
			Analogue out-puts 1 .. 20	Controller CAN input
			Digital inputs 1 .. 40	Alarm On/Off Initial value indication
			Digital outputs 1 .. 40	Controller Limiter Timer
			Switch 1 .. 10	Internal/external switch/button function, also via Modbus TCP/ Profibus, e.g. burner On
			Setpoint 1 .. 10	Internal/external setpoint, also via Modbus TCP/Profibus, e.g. burner setpoint
				Analogue input Modbus 1..10 External analogue input via Modbus TCP
				Digital input Modbus 1..10 External digital input via Mod- bus TCP

Menu structure continued

	System	Date/time	Incl. enabling/disabling daylight saving time switchover
		Backlight/home screen	Customise display settings, define home screen
		Password	PWL 1 and 2
		I/O module	Incl. dynamic overview, terminal diagrams
		Save configuration	Equipment configuration, save all settings
		Language	German/English/French
		Network	Unique device IP
		CAN bus info	Device IDs, type, version
		Communication/interface allocation	Modbus TCP/Profibus Data sheets for OPC, Profibus, Modbus
		PLC/Visu/OS/Info	PLC Run/Stop/Reset/ Password Info, Visu/OS Info
	Burner manufacturer	Landis&Staefa, Lamtec Two burners possible	
	Help	Help, navigation via links	
			Setup burner Fuel/operating mode Setpoint/standby mode/ operating hours
	Example		Info Common inputs and outputs Capacity controller Actuator position
1 and 2			Alarm buffer Alarm/history

System malfunctions

Indications, diagnosis and remedies



Attention

Please check the following before fault diagnosis:

Supply voltage:

To ensure trouble-free operation, make sure all bus nodes are supplied with power via an external 24 V DC SELV power supply unit that is isolated from connected loads. Do not use the bus power supply for GESTRA control units for supplying power to the SPECTOR^{control} or connected equipment.

Wiring:

Does the wiring conform to the wiring diagram?

Error	Remedy
Internal sum current of WAGO I/O module too high	If the sum of the internal power consumption exceeds the sum current for bus modules, position a potential feed terminal with bus power supply unit (750-613) upstream from the module where the admissible sum current was exceeded. This current is established during configuration of the I/O module in the SC.
Warning alarm "WAGO I/O module: Configuration not plausible"	Always set the correct number of established I/O modules.
WAGO I/O module not connected	Is the node ID/ baud rate correct (250kB/ID: 126)? Have you connected the end module? Is the internal power consumption adhered to?
Warning alarm "Controller xxx: Manual mode"	The controller is in manual mode.
Warning message "Display dirty"	The IR grid is soiled. There is a cleaning tool in System/ Display.
Burner Modbus TCP communication cannot be established	Connected to "Ether 2"? Are Modbus parameters correctly set? See Lamtec documentation.
New CAN nodes cannot be allocated	If a CAN node was deleted from the list, this position can only be allocated to another CAN node after you have rebooted the SC.



Attention

- Please pay attention to the Installation & Operating Manuals of the connected equipment.

Action against high-frequency interference

High-frequency interference can be caused by out-of-phase switching operations. If such interference occurs and results in sporadic failure, we recommend taking the following action to suppress interference:

- Provide inductive loads with RC combinations as per manufacturer's specifications.
- Route bus lines separately from power lines.
- Increase the distance from sources of interference.
- Check the shield connection to the central earthing point (CEP) in the control cabinet.
- Suppress HF interference using hinged-shell ferrite rings.



Attention

- An alarm is triggered when the CAN bus line is interrupted.

Display of system malfunctions in the alarm and error list using fault codes continued

Fault codes for the URS 60/URS 61 safety control unit			
Fault code	Internal designation	Possible faults	Remedy
E.006	ProbeCntErr	No electrode configured	Check code switch
E.007	DipKonfErr	Inconsistent code switch setting	Check code switch
E.008	Ch1Ch2DiffErr	EMC or internal error	Check installation location Replace safety control unit
E.009	Relais1Err	Error in relay 1	Check installation location Replace safety control unit
E.010	Relais2Err	Error in relay 2	Check installation location Replace safety control unit
E.012	DoubleStandByErr	Two electrodes are bridged	Check both monitoring units (SRL 6-60)
E.013	Probe1Err	Collective fault in channel 1	Check channel 1
E.014	Probe2Err	Collective fault in channel 2	Check channel 2
E.015	Probe3Err	Collective fault in channel 3	Check channel 3
E.016	Probe4Err	Collective fault in channel 4	Check channel 4
E.019	V6Err	EMC or voltage error	Check installation location Replace safety control unit
E.020	V5Err	EMC or voltage error	Check installation location Replace safety control unit
E.021	V3Err	EMC or voltage error	Check installation location Replace safety control unit
E.022	V1Err	EMC or voltage error	Check installation location Replace safety control unit
E.023	V12Err	EMC or voltage error	Check installation location Replace safety control unit
E.024	CANErr	Wrong baud rate or wiring error	Check the baud rate, wiring and terminating resistors
E.025	ESMG1 (µC1Err)	EMC error or internal process error	Check installation location Replace safety control unit
E.026	BIST (SelftestErr)	EMC or internal error	Check installation location Replace safety control unit

All fault codes from E.001 to E.027 not listed here are available as reserves

System malfunctions continued

Display of system malfunctions in the alarm and error list using fault codes continued

Fault codes for NRR 2-60 / NRR 2-61 level controllers, LRR 1-60 conductivity controller and URW 60 universal converter			
Fault code	Internal designation	Possible faults	Remedy
E.004	PlausSwitchpointErr	MIN switchpoint set higher than MAX switchpoint	Reset the switchpoints
E.005	InitTestErr	Internal error	Reboot the unit and replace if necessary
E.006	WalkThroughAppErr	Internal error	Reboot the unit and replace if necessary
E.007	WalkThroughTestErr	Internal error	Reboot the unit and replace if necessary
E.008	PlausSteamErr	Measuring range settings implausible Steam flowrate: Min > Max	Check/reset steam flowrate measuring range
E.009	PlausWaterErr	Measuring range settings implausible Feedwater flowrate: Min > Max	Check/reset feedwater flowrate measuring range
E.010	PlausPotiErr	Calibration points implausible Valve: CLOSED (0 %) > OPEN (100 %)	Check Valve CLOSED (0 %) and Valve OPEN (100 %) calibration points
E.011	PlausErr	Min > Max measuring range settings not plausible	Check/reset measuring range
E.012	ProbeCommErr	Breakdown in communication with electrode	Check baud rate, group number, wiring and terminating resistors
E.013	OvertempErr	Ambient temperature of electrode > 75°C	Check electrode installation location, reduce ambient temperature of electrode terminal box
E.014	ProbeStoerungErr	General electrode error	Check electrode

Display of system malfunctions in the alarm and error list using fault codes

Fault codes for NRR 2-60 / NRR 2-61 level controllers, LRR 1-60 conductivity controller and URW 60 universal converter			
Fault code	Internal designation	Possible faults	Remedy
E.015	SteamMinErr	Steam flowrate measuring current < 4 mA	Check steam flowrate current transmitter and replace if necessary Check electrical connection
E.016	SteamMaxErr	Steam flowrate measuring current > 20 mA	Check steam flowrate current transmitter and replace if necessary Check electrical connection
E.017	FeedwaterMinErr	Feedwater flowrate measuring current < 4 mA	Check feedwater flowrate current transmitter and replace if necessary Check electrical connection
E.018	FeedwaterMaxErr	Feedwater flowrate measuring current > 20 mA	Check feedwater flowrate current transmitter and replace if necessary Check electrical connection
E.019	ProbeLFShortOpenErr	Conductivity electrode faulty (sensor break or short circuit)	Check conductivity electrode and replace if necessary Check electrical connection
E.020	ProbePtShortOpenErr	Pt1000 temperature sensor faulty (sensor break or short circuit)	Check Pt1000 temperature sensor and replace if necessary Check electrical connection
E.021	MinErr	Measuring current < 4 mA	Check current transmitter and replace if necessary Check electrical connection
E.022	MaxErr	Measuring current > 20 mA	Check current transmitter and replace if necessary Check electrical connection
E.024	CANErr	Wrong baud rate or wiring error	Check baud rate, group number, wiring and terminating resistors
E.025	Pump1Err	Pump 1 output too low or pump faulty	Check controller parameters and switching thresholds of pumps Check pump electrical connection Replace pump if necessary
E.026	Pump2Err	Pump 2 output too low or pump faulty	Check controller parameters and switching thresholds of pumps Check pump electrical connection Replace pump if necessary

All fault codes from E.001 to E.027 not listed here are available as reserves

Disposal

The equipment must be disposed of in accordance with statutory waste disposal regulations.

Taking out of service

1. Switch off the supply voltage and secure so that it cannot be turned on again.
2. Unplug the mains connector from the device.
3. Remove all plug and socket connections (e.g. CAN bus line, Ethernet connection, etc.).
4. Unscrew the screws and remove the retaining clips.
5. Carefully push the device out of the cutout in the door of the control cabinet.

For your notes

For your notes



You can find our authorised agents around the world at: **www.gestra.com**

GESTRA AG

Münchener Straße 77

28215 Bremen

Germany

Tel. +49 421 3503-0

Fax +49 421 3503-393

E-mail info@de.gestra.com

Web www.gestra.com