



Level Controller

NRR 2-50

NRR 2-51

EN
English

Original Installation Instructions
819180-04

Contents

Page

Important notes

Intended use	4
Function	4
Safety information	5

Directives and standards

VdTÜV Bulletin "Wasserstand 100" (Water Level 100)	5
LV (Low Voltage Directive) and EMC (Electromagnetic Compatibility)	5
ATEX (Atmosphère Explosible)	5
Notes on the Declaration of Conformity/Manufacturer's Declaration CE	5
Approval for Marine Use	5

Technical data

NRS 2-50 / NRR 2-51	6
Contents of package	7

In the control cabinet: Installing the level controller

Dimensions of the NRR 2-50 / NRR 2-51	8
Key	8
Installation in control cabinet	8
Name plate/identification	9

In the control cabinet: Electrically connecting the level controller

Wiring diagram for level controller NRR 2-50	10
Key	10
Wiring diagram for level controller NRR 2-51	11
Key	11
Supply voltage connection	12
Connection of output contacts	12
Connecting the level electrode/level transmitter	12
Output of manipulated variable Y or connection of actual value output (optional)	12
Tools	12

In the system: Electrically connecting the level electrode/transmitter

Connection of level electrode/level transmitter	13
---	----

Factory settings	13
------------------------	----

Changing factory settings

Changing the function and input of the level electrode/transmitter.....	14
---	----

Operating the level controller

Meaning of codes on the 7-segment display	16
Setting the measuring range	17
Additional information on control parameters	17

Commissioning

Setting parameters.....	18
Setting the measuring range	19

Operation, alarm and testing

Setting switchpoints and control parameters.....	20
Level controller NRR 2-50 Displays	21
Level controller NRR 2-51 Displays	21
Check function of MIN/MAX output contacts	22

Fault indications and troubleshooting

Display, diagnosis and troubleshooting	23
--	----

Further information

Action against high-frequency interference	24
Replacing/taking the equipment out of service	24
Disposal	24

Important notes

Intended use

The NRR 2-50 / NRR 2-51 level controller is used in combination with NRG 2-.. level electrodes or the NRG 26-. level transmitters as a limit switch and water level controller, e.g. in steam and water boiler systems, or in condensate and feedwater tanks. The level controller indicates when a MIN and MAX water level has been reached, and opens or closes a control valve.

The NRR 2-50 / NRR 2-51 level controller can be combined with the NRG 21-.. or NRG 26-21 level electrodes and the NRG 26-. level transmitters.

Function

The **NRR 2-50 / NRR 2-51 level controller** processes the level-dependent voltage signals from the NRG 2-.. level electrodes or the level-dependent current signal from the NRG 26-. level transmitters. These input signals are standardised by the controller to 0 and 100 % of the boiler measuring range, and shown as an actual value on the 7-segment LED display.

Level controller NRR 2-50: The level controller works with an electrically actuated control valve as a 3-position stepping controller with proportional-plus-integral control action (**PI controller**). If the actual value deviates from the setpoint, the electric actuator is triggered by two output contacts and two flashing LEDs indicate whether the control valve is opening or closing.

The controller can be configured for fill or discharge control.

A further output contact indicates when a MIN or MAX water level is reached (the desired function can be selected by a switch). After the de-energizing time has elapsed, the output contact switches over and the MIN or MAX LED lights up.

Level controller NRR 2-51: The level controller works with an electro-pneumatically actuated control valve as a continuous controller with proportional-plus-integral control (**PI controller**). In the event of deviations from the setpoint, it outputs a current of 4-20 mA as manipulated variable Y.

The controller can be configured for fill or discharge control.

If the MIN or MAX water level is reached, after the de-energizing delay the MIN or MAX output contact switches over in the level controller, and the MIN or MAX LED lights up.

Level controller NRR 2-50 / NRR 2-51: Faults in the level electrode, the level transmitter, the electrical connection or the settings are indicated as error codes on the 7-segment LED display. In the event of a malfunction, the MIN and MAX alarm is triggered.

If faults occur only in the **NRR 2-50 / NRR 2-51 level controller**, the MIN and MAX alarm is triggered and the system is restarted.

Parameters can be changed or the MIN/MAX alarm simulated by operating the rotary knob.

For external level indication, the **NRR 2-50 level controller** is optionally available with a 4 - 20 mA actual value output.

Important notes continued

Safety information

The equipment may only be installed, electrically connected and commissioned by suitable persons with the relevant instruction/training.

Maintenance and modification may only be performed by authorised staff who have undergone specific instruction/training.



Danger

The terminal strips of the equipment are live during operation!

There is a risk of serious injury due to electric shock!

Always cut off the power supply to the equipment before installing, removing or connecting terminal strips!



Important

The name plate specifies the features of the equipment. Do not commission or operate any item of equipment that does not have its own specific name plate.

Directives and standards

VdTÜV Bulletin "Wasserstand 100" (Water Level 100)

The NRR 2-50 / NRR 2-51 level controller, in combination with the NRG 2-.. level electrode and the NRG 26-.. level transmitter, is type approved to the VdTÜV Bulletin "Water Level 100".

The VdTÜV "Wasserstand (=Water Level) 100" describes the requirements for water level control and limiting equipment for boilers.

LV (Low Voltage Directive) and EMC (Electromagnetic Compatibility)

The equipment conforms to the requirements of the Low Voltage Directive 2014/35/EU and the EMC Directive 2014/30/EU.

ATEX (Atmosphère Explosible)

The equipment must **not** be used in potentially explosive atmospheres, in accordance with European Directive 2014/34/EU.

Notes on the Declaration of Conformity/Manufacturer's Declaration CE

For details on the conformity of our equipment with European Directives, please refer to our Declaration of Conformity or our Manufacturer's Declaration.

The current Declaration of Conformity/Manufacturer's Declaration is available at www.gestra.com → documents, or can be requested from us.

Approval for Marine Use

The NRR 2-5.. level controller in combination with the NRG 26-.. level transmitter is approved for marine use.

Technical data

NRS 2-50 / NRR 2-51

Supply voltage

24 VDC +/- 20%

Fuse

external 0.5 A (semi-delay)

Power consumption

4 VA

Connection of level electrode, level transmitter (selected by switch)

1 input for NRG 21-.. and NRG 26-21 level electrode, 3 poles and screen, or

1 analogue input 4-20 mA, e.g. for NRGT 26-.. level transmitter, 2 poles and screen.

Supply voltage to level electrode

12 VDC

Outputs:

NRR 2-50: 2 floating changeover contacts, 8 A 250 V AC / 30 V DC $\cos \varphi = 1$
(control valve open/closed).

1 floating changeover contact, 8 A 250 V AC / 30 V DC $\cos \varphi = 1$.

De-energizing delay 3 seconds (MIN/MAX alarm, can be switched)

NRR 2-51: 2 floating changeover contacts, 8 A 250 V AC / 30 V DC $\cos \varphi = 1$.

De-energizing delay 3 seconds (MIN/MAX alarm)

1 analogue output 4-20 mA, max. load 500 ohms (manipulated variable Y).

Inductive loads must have interference suppression (RC combination) as per the manufacturer's specification.

NRR 2-50: 1 analogue output 4-20 mA, max. load 500 ohms, e.g. for an actual value display (optional).

Displays and controls

1 rotary knob with integrated push-button for MIN/MAX alarm test and parameter setting,

1 4-digit 7-segment LED display, green

2 red LEDs for MIN/MAX alarm,

2 amber LEDs for control valve opening/closing (NRR2-50 only)

1 4-pole code switch for configuration.

Housing

Housing material, base: black polycarbonate; front: grey polycarbonate

Conductor size: 1 x 4.0 mm² solid, per wire, or

1 x 2.5 mm² per lead with sleeve to DIN 46228, or

2 x 1.5 mm² per lead with sleeve to DIN 46228 (min. \varnothing 0.1 mm)

Terminal strips can be removed separately

Housing attachment: Mounting clip on support rail TH 35, EN 60715

Electrical safety

Degree of contamination 2 for installation in control cabinet with degree of protection IP 54, fully insulated

Degree of protection

Housing: IP 40 to EN 60529

Terminal strip: IP 20 to EN 60529

Weight

approx. 0.2 kg

Technical data continued

NRS 2-50 / NRR 2-51 continued

Ambient temperature

at moment of switch-on 0 ° ... 55 °C
in operation –10 ... 55 °C

Transport temperature

–20 ... +80 °C (<100 hours), only switch on after a defrosting period of 24 hours.

Storage temperature

–20 ... +70 °C, only switch on after a defrosting period of 24 hours.

Relative humidity

max. 95%, no moisture condensation

Approvals:

TÜV Certificate

VdTÜV Bulletin "Wasserstand 100" (Water Level 100): Requirements for water level control and limiting equipment.

Type approval no.: TÜV · WR · XX-425
(see name plate)

Contents of package

NRR 2-50

1 level controller NRR 2-50
1 installation & operating manual

NRR 2-51

1 level controller NRR 2-51
1 installation & operating manual

In the control cabinet: Installing the level controller

Dimensions of the NRR 2-50 / NRR 2-51

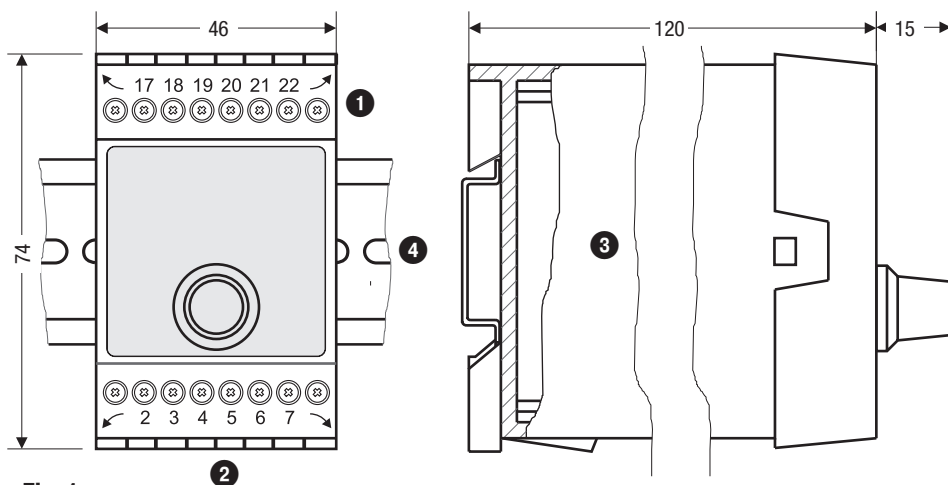

Fig. 1

Key

- | | | | |
|---|----------------------|---|------------------------------|
| 1 | Upper terminal strip | 3 | Housing |
| 2 | Lower terminal strip | 4 | Support rail TH 35, EN 60715 |

Installation in control cabinet

The NRR 2-50 / NRR 2-51 level controller is clipped onto a type TH 35, EN 60715 support rail in the control cabinet. **Fig. 1** 4

Name plate/identification

Name plate NRR 2-50, top

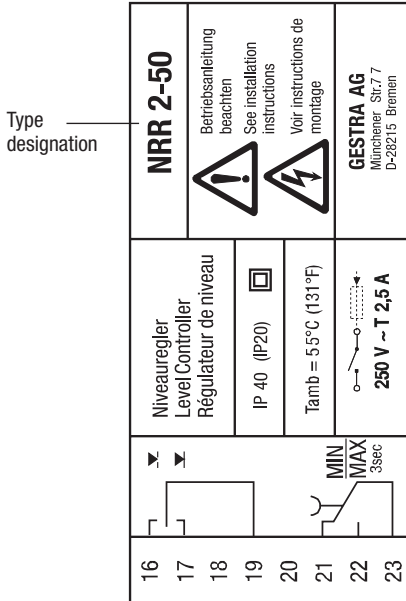

Name plate NRR 2-51, top

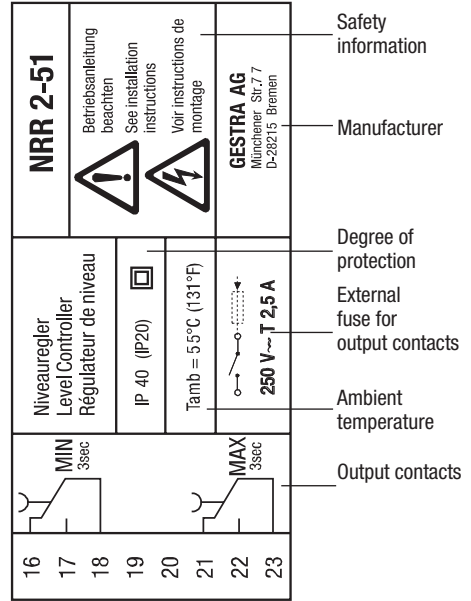

Name plate, bottom

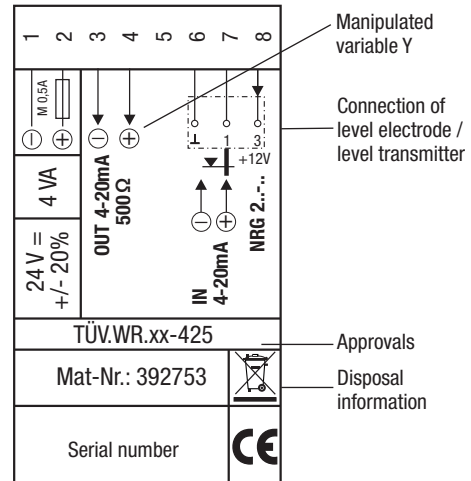
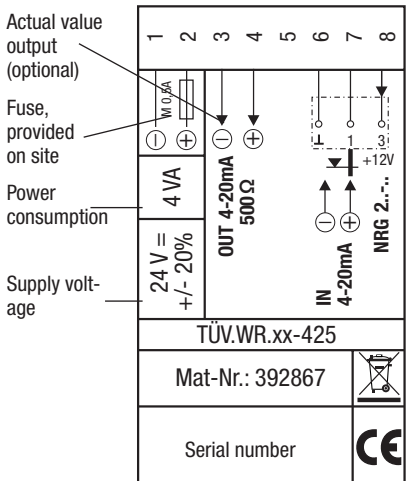

Fig. 2

In the control cabinet: Electrically connecting the level controller

Wiring diagram for level controller NRR 2-50

NRR 2-50

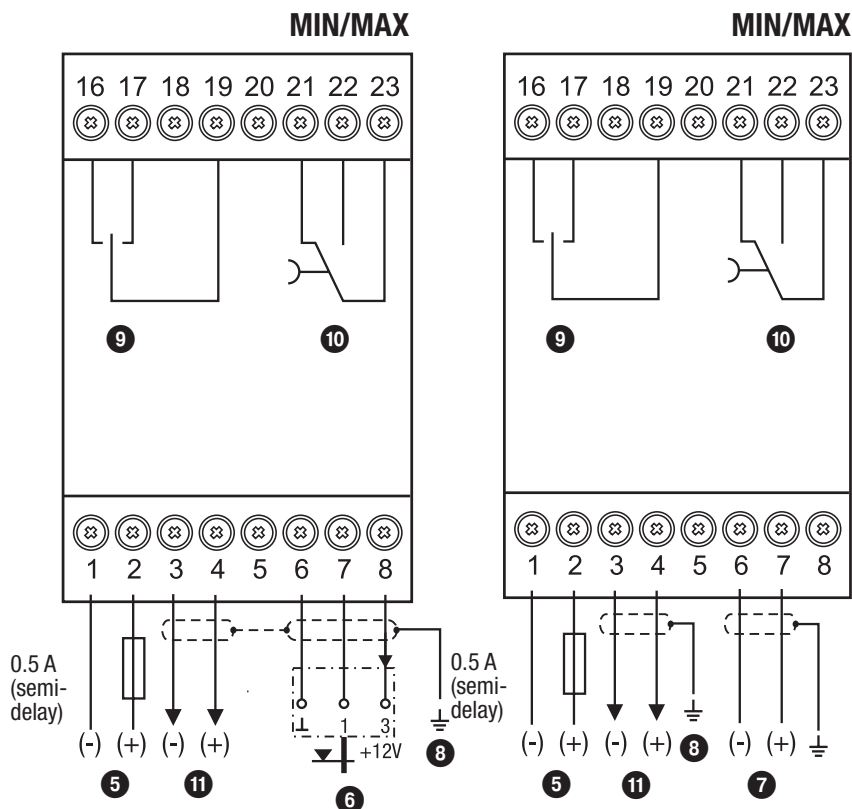

Fig. 3

Key

- 5 Supply voltage connection **24 V DC** with semi-delay fuse 0.5 A provided on site
- 6 Level electrode NRG 21-.. / NRG 26-21.
Max. 3 NRS/NRR 2-5.. devices can be connected (connection in parallel)
- 7 Level transmitter NRGT 26-., 4-20 mA, with earthing point.
Max. 3 NRS/NRR 2-5.. devices can be connected (series connection)
- 8 Central earthing point (CEP) in control cabinet
- 9 Output contact for control valve actuation
- 10 MIN/MAX output contact, de-energizing delay 3 seconds
- 11 Actual value output 4-20 mA (optional)

Wiring diagram for level controller NRR 2-51

NRR 2-51

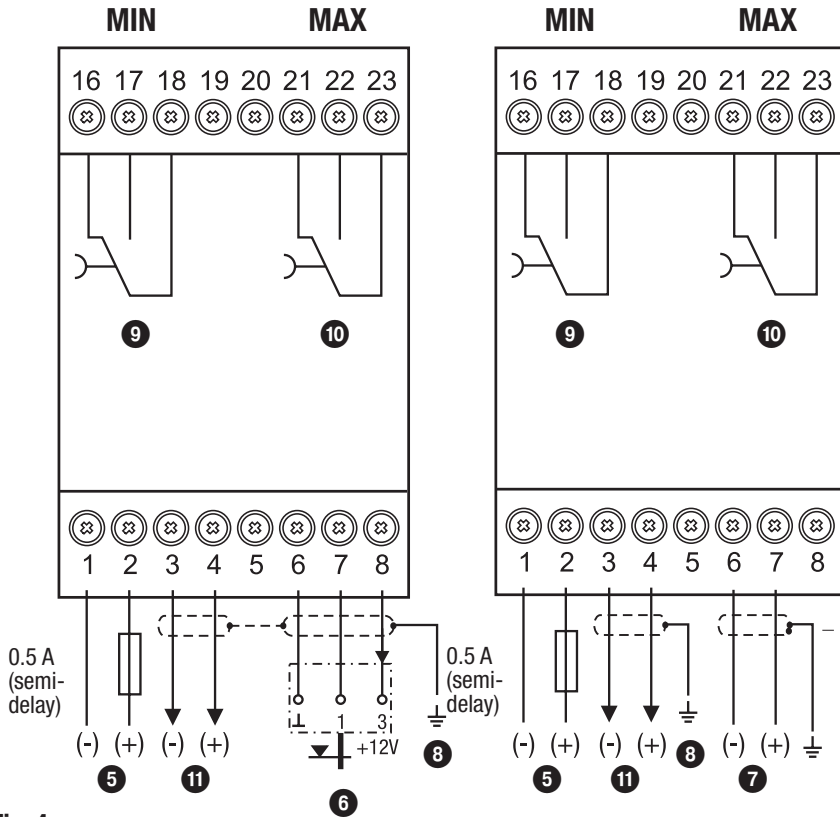

Fig. 4

Key

- 5** Supply voltage connection **24 V DC** with semi-delay fuse 0.5 A provided on site
- 6** Level electrode NRG 21-.. / NRG 26-21.
Max. 3 NRS/NRR 2-5.. devices can be connected (connection in parallel)
- 7** Level transmitter NRG 26-., 4-20 mA, with earthing point.
Max. 3 NRS/NRR 2-5.. devices can be connected (series connection)
- 8** Central earthing point (CEP) in control cabinet
- 9** MIN output contact, de-energizing delay 3 seconds
- 10** MAX output contact, de-energizing delay 3 seconds
- 11** Output 4-20 mA, manipulated variable Y

Supply voltage connection

The equipment is supplied with 24 V DC and has an external semi-delay 0.5 A fuse. Please use a safety power supply unit with safe electrical isolation.

This power supply unit must be electrically isolated from dangerous live voltages and meet the requirements for double or reinforced insulation in accordance with one of the following standards: DIN EN 50178, DIN EN 61010-1, DIN EN 60730-1 or DIN EN 60950.

Connection of output contacts

Wire the upper terminal strip **1** (terminals 16-23) according to the desired switching functions. Provide an external slow-blow 2.5 A fuse for the output contacts.

When inductive loads are switched off, voltage spikes are produced that may have a major adverse effect on the operation of control and measuring systems. Connected inductive loads must therefore have interference suppression (RC combination) as per the manufacturer's specifications.

Connecting the level electrode/level transmitter

For connecting the equipment, please use a screened, multi-core control cable with a minimum conductor size of 0.5 mm², e.g. LiYCY 4 x 0.5 mm², maximum length 100 m.

Max. 3 NRS/NRR 2-5.. switches/controllers can be connected to a level electrode or a level transmitter.

Wire the terminal strip as shown in the wiring diagram. **Fig. 3, 4**

Connect the screen as shown in the wiring diagram.

Route the connecting cable between items of equipment separately from power lines.

Output of manipulated variable Y or connection of actual value output (optional)

For connection, please use a screened, multi-core control cable with a minimum conductor size of 0.5 mm², e.g. LiYCY 2 x 0.5 mm², maximum length 100 m.

Please note the load of max. 500 ohms (output of manipulated variable Y).

Wire the terminal strip as shown in the wiring diagram. **Fig. 3, 4**

Connect the screen **once only** to the central earthing point (CEP) in the control cabinet.

Route the connecting cable between items of equipment separately from power lines.

Any item of equipment that you wish to connect to the terminals for the output of manipulated variable Y or actual value output 4-20 mA (optional) must be certified to have at least double or reinforced insulation to DIN EN 50178 or DIN 61010-1 or DIN EN 60730-1 or DIN EN 60950 between the current loop and live parts of the equipment that are not supplied with safety extra-low voltage (SELV).



Important

- Do not use unused terminals as support point terminals.

Tools

- Screwdriver size 3.5 x 100 mm, fully insulated to VDE 0680-1.

In the system: Electrically connecting the level electrode/transmitter

Connection of level electrode/level transmitter

The NRR 2-50 / NRR 2-51 level controller can be combined with the NRG 21-.. or NRG 26-21 level electrodes and the NRGT 26-. level transmitter.

For connecting the equipment, please use a screened, multi-core control cable with a minimum conductor size of 0.5 mm², e.g. LiYCY 4 x 0.5 mm², maximum length 100 m.

Connect the screen as shown in the wiring diagram.



Important

- Please commission the equipment as described in the NRG 21-.. , NRG 26-21 or NRGT 26-. installation & operating manuals.
- Route the connecting cable between items of equipment separately from power lines.
- The level transmitter must be connected to its own dedicated power supply.

Factory settings

Level controller NRR 2-50

- De-energizing delay: 3 sec. (factory set)
- Voltage input for the connection of an NRG 21-.. or NRG 26-21 level electrode.
- MAX switchpoint AL.Hi = 80 %
- MIN switchpoint AL.Lo = 20 %
- Setpoint SP = 50 %
- Proportional band Pb = 20 % of setpoint
- Integral action time ti = 0 %
- Dead band = +/- 5 % of setpoint
- Valve travel time tt = 40 s
- Calibration value CAL.P = 100 %
- Fill control function
- MIN/MAX output contact set as MAX alarm

Code switch 13: S1,S2,S3, S4 OFF

Level controller NRR 2-51

- De-energizing delay: 3 sec. (factory set)
- Voltage input for the connection of an NRG 21-.. or NRG 26-21 level electrode.
- MAX switchpoint AL.Hi = 80 %
- MIN switchpoint AL.Lo = 20 %
- Setpoint SP = 50 %
- Proportional band Pb = 20 % of setpoint
- Integral action time ti = 0 %
- Dead band = +/- 5 % of setpoint
- Calibration value CAL.P = 100 %
- Fill control function

Code switch 13: S1,S2,S3, S4 OFF

Changing factory settings



Danger

The upper terminal strip of the equipment is live during operation.

There is a risk of serious injury due to electric shock!

Always **cut off the power supply** to the equipment before installing, removing or connecting the terminal strip!

Changing the function and input of the level electrode/transmitter

The input and function are determined by the setting of code switch **13**.

To make changes, you can access the code switch as follows:

▲ Switch off the supply voltage.

■ **Remove the lower terminal strip. Fig. 5**

- Insert a screwdriver between the terminal strip and the front frame, to the right and left of the arrow markings.
- Release the terminal strip on the right and left sides, by turning the screwdriver in the direction of the arrow.
- Remove the terminal strip.

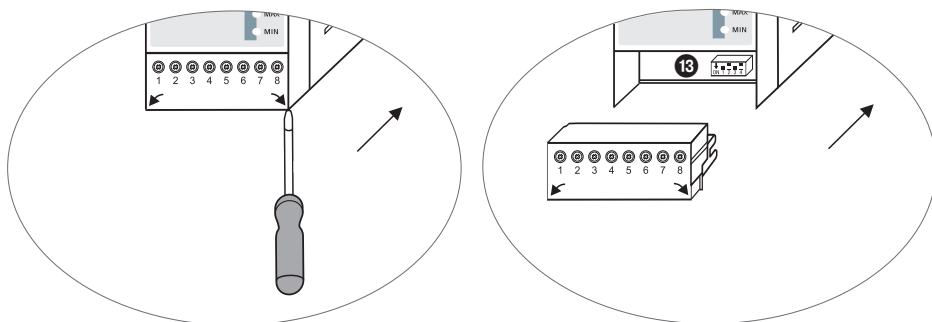

Fig. 5

When your changes are complete:

- Refit the lower terminal strip.
- Switch the supply voltage back on. The equipment restarts

If you wish to change the input or the function, set code switch 13 S1 to S3 in accordance with the table Fig. 6.

Code switch 13 			
Toggle switch, white			
Level controller NRR 2-50	S 1	S 2	S 3
Output contact set for MAX alarm	OFF		
Output contact set for MIN alarm	ON		
Level controller NRR 2-50 / NRR 2-51			OFF
Input for connection of level electrode NRG 21-.. or NRG 26-21			ON
Input for connection of level transmitter NRGT 26-.*		OFF	
Discharge control		ON	

Fig. 6 grey = factory setting



Important

* When connecting the NRGT 26-. level transmitter, please set the upper and lower ends of the measuring range **only** in the transmitter. Here, please pay attention to the NRGT 26-. installation & operating manual.

Do not change the code switch 13 settings of S4!

Operating the level controller

Meaning of codes on the 7-segment display

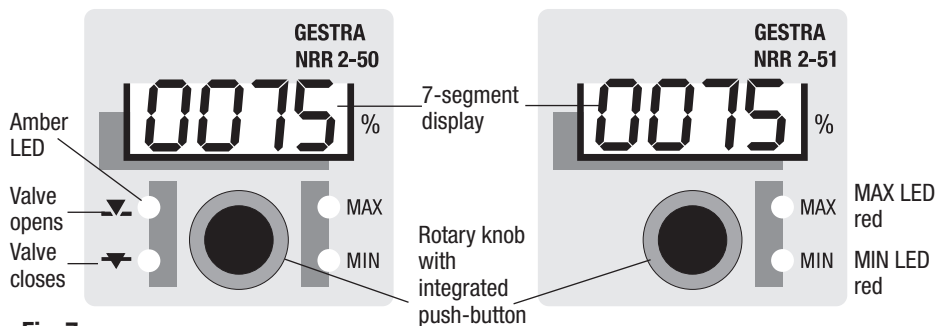

Fig. 7

Code	Meaning	
Indicated when rotary knob is turned clockwise:		
AL.Hi	Alarm High	MAX switchpoint
AL.Lo	Alarm Low	MIN switchpoint
SP	Setpoint	Setpoint
Pb	Proportional band	adjustable between 0 and 100 %
ti	Time integral	Integral action time, adjustable between 0 and 100 seconds
tt	Motor travel time	Valve travel time (NRR 2-50 only), adjustable between 10 and 600 seconds
tEst	Test	Tests output relays

CAL.L	Calibrate Low	Only if level electrode NRG 21-.. or NRG 26-21 is connected	Sets lower end of measuring range
CAL.P	Calibrate %		adjustable between 25 and 100%
CAL.H	Calibrate High		Sets upper end of measuring range

Indicated in parameterization mode		
quit	Confirm	Input is not confirmed
done	Done	Input is confirmed

Indicated if malfunctions occur		
E.005	Error	Faulty level electrode/transmitter, measuring voltage/current too low
E.006	Error	Faulty level electrode/transmitter, measuring voltage/current too high
E.012	Error	Lower and upper ends of measuring range changed around
E.013	Error	MIN switchpoint higher than MAX switchpoint

Setting the measuring range

- A** Lower end of measuring range, adjustable
- B** Upper end of measuring range, adjustable
- C** Measuring range [mm] = xxx %
- D** Inactive range
- E** Maximum installed length at 238 °C

Set the lower and upper ends of the measuring range for your fill level measurement. The result is the measuring range **C**. Please calculate this measuring range in percent.

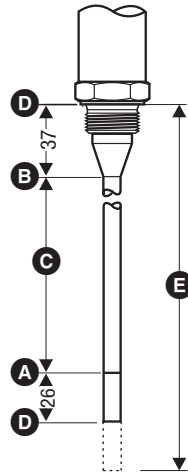

NRG 2.-..
NRGT 26.-.



Important

When connecting the NRGT 26- level transmitter, please set the upper and lower end of the measuring range **only** in the transmitter.

Additional information on control parameters

Parameter	Control deviation	Control valve
Proportional band Pb	Larger	Large remaining deviation Responds slowly
	Smaller	Small remaining deviation Responds quickly and may continually open/close
	Example	Measuring range 100% = 200 mm of sightglass Setpoint SP = 80 % of measuring range = 160 mm Proportional band Pb = +/- 20% of setpoint = +/- 16% = +/- 32 mm If the measuring range is 100% (200 mm) and the setpoint is 80% (160 mm), the proportional range will be +/- 16% (+/- 32 mm) or in the range of 128 to 192 mm.
Integral action time ti	Larger	Slow correction of deviations Responds slowly
	Smaller	Fast correction of deviations, control loop may tend to overshoot Responds quickly

Commissioning

Setting parameters

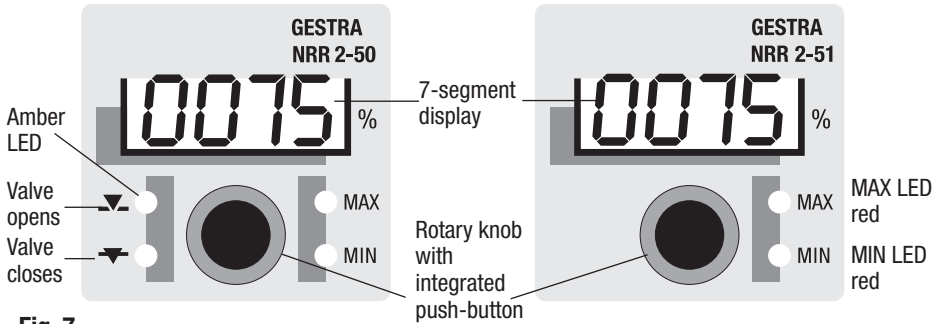

Fig. 7

Start		
Action	Display	Function
Switch on supply voltage. Water level between MIN and MAX.	7-segment display shows software and equipment version	System test, takes approx. 3 sec.
	7-segment display shows actual value	System switches to operating mode

Setting parameters		
Action	7-segment display	Function
Turn rotary knob until desired parameter is shown	Display toggles between parameter and saved value.	Selecting the parameter
Press and hold the push-button (on rotary knob)	First digit (0000) flashes.	Parameterization mode active. You can change the first digit.
Turn rotary knob	A new value is displayed.	Turning clockwise increases the value, turning anti-clockwise reduces the value.
Briefly press push-button	2nd, 3rd or 4th digit flashes. (from right to left)	2nd, 3rd or 4th digit can now be changed using the rotary knob. Turning clockwise increases the value, turning anti-clockwise reduces the value.
When your entries are complete: press and hold the push-button within 3 sec.	done is displayed. Next, the display toggles between the parameter and the new value.	Input is confirmed. System switches back to the parameter.
<i>If you do not confirm your entry within 3 sec. or you do not make any further entries:</i>	quit is briefly displayed. After this, the display toggles between the parameter and the old value.	If you do not confirm, your entries will not be applied. Please repeat the procedure. If you do not confirm, the system switches back to the parameter.
Turn the rotary knob until the next parameter is shown. Or turn the rotary knob until the actual value is displayed. Or after 30s, the actual value is displayed automatically.		

Setting the measuring range

Level electrode NRG 2.-.. only : Setting the measuring range, option 1		
Action	Display	Function
Reduce water level until start of measuring range A .		
Select parameter CAL.L.	After a short time, a hexadecimal number flashes.	Calibrate start of measuring range.
Press push-button.	The current hexadecimal number flashes.	
Press button again within 3 sec. (press and hold)	done is displayed. After this, CAL.L and the hexadecimal alternate on the display. After a short time, 0000 % appears.	Input is confirmed. (actual value output = 4 mA)
Fill tank until top end of measuring range B .		
Select parameter CAL.H and press push-button.	After a short time, a hexadecimal number flashes.	Calibrate top end of measuring range.
Press push-button.	The current hexadecimal number flashes.	
Press button again within 3 sec. (press and hold)	done is displayed. After this, CAL.H and the hexadecimal alternate on the display. After a short time, 0100 % appears.	Input is confirmed. (actual value output = 20 mA)

Level electrode NRG 2.-.. only : Setting the measuring range, option 2		
Action	Display	Function
Reduce water level until start of measuring range A .		
Select parameter CAL.L.	After a short time, a hexadecimal number flashes.	Calibrate start of measuring range.
Press push-button.	The current hexadecimal number flashes.	
Press button again within 3 sec. (press and hold)	done is displayed. After this, CAL.L and the hexadecimal alternate on the display. After a short time, 0000 % appears.	Input is confirmed. (actual value output = 4 mA)
Fill tank up to at least 25% of the measuring range.		
Select parameter CAL.H.	After a short time, a hexadecimal number flashes.	Calibrate at a percentage of the measuring range, e.g. 25%.
Press push-button.	The current hexadecimal number flashes.	
Press button again within 3 sec. (press and hold)	done is displayed. After this, CAL.H and the hexadecimal alternate on the display. After a short time, 0100 % appears.	Input is confirmed. (actual value output = 20 mA)
Select parameter CAL.P and set and save a percentage, e.g. 25%.	CAL.P interpolates the value measured at CAL.H to find 100% of the measuring range. CAL.P can be adjusted between 25 and 100%.	



Note

- Adjusting the measuring range: The advantage of option 2 is that the tank only has to be partially filled.

Operation, alarm and testing

Setting switchpoints and control parameters

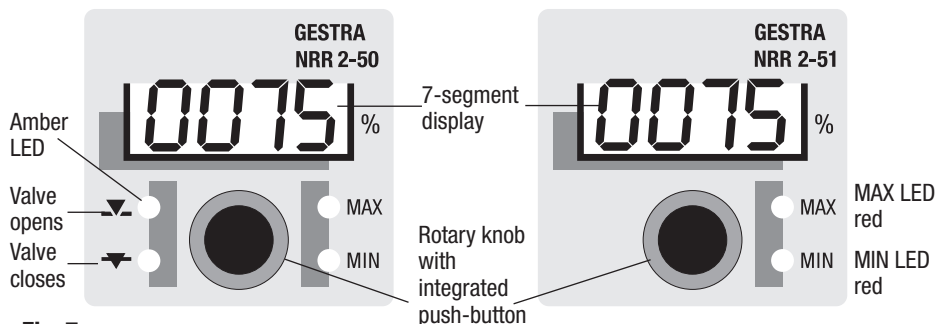

Fig. 7

Setting the MIN/MAX switchpoints	
Select parameter AL.Lo, enter and save the desired percentage.	MIN switchpoint setting between 0-100 %
Select parameter AL.Hi, enter and save the desired percentage.	MAX switchpoint setting between 0-100 %
Setting the setpoint	
Select parameter SP, enter and save the desired percentage.	Setpoint setting between 0-100 % Please take the settings for MIN/MAX switchpoints into consideration.
Setting the proportional band	
Select parameter Pb, enter and save the desired percentage.	Proportional band setting between 0-100 %
Setting the integral action time	
Select parameter ti, enter and save the desired percentage.	Integral action time settings between 0-100 s.
Setting the valve travel time (NRR 2-50 only)	
Select parameter tt, enter and save the desired percentage.	Integral action time settings between 10-600 s.



Note

- The NRR 2-50 level controller is only equipped with **one** output contact for limit indications. Therefore, please define its function (MAX or MIN alarm) using the code switch **13**. Fig. 5, 6.
- The actual value is shown on the 7-segment display.

Operation, alarm and testing continued

Level controller NRR 2-50 Displays

Operation		
Action	Display	Function
Actual value = setpoint	Valve and MIN/ MAX LEDs do not light up	Valve output contact 16/17/19 open. MIN output contacts 16/18 open, 17/18 closed. MAX output contacts 21/23 open, 22/23 closed.

Value above or below setpoint		
Value above or below setpoint.	Valve OPEN LED flashes amber	Control valve opens, valve output contact 16/19 closed.
	or	
	Valve OPEN CLOSED flashes amber	Control valve opens, valve output contact 17/19 closed.

MAX alarm		
Switchpoint for MAX water level reached or exceeded.	MAX LED flashes red	De-energizing delay in progress.
	MAX LED lights up red	De-energizing delay elapsed, output contacts 21/23 closed, 22/23 open.
or		
MIN alarm		
Switchpoint for MIN water level reached or exceeded.	MIN LED flashes red	De-energizing delay in progress.
	MIN LED lights up red	De-energizing delay elapsed, output contacts 21/23 closed, 22/23 open.

Level controller NRR 2-51 Displays

Operation		
Action	Display	Function
Actual value = setpoint	MIN and MAX LEDs do not light up	MIN output contacts 16/18 open, 17/18 closed. MAX output contacts 21/23 open, 22/23 closed.

MIN alarm		
Switchpoint for MIN water level reached or exceeded.	MIN LED flashes red	De-energizing delay in progress.
	MIN LED lights up red	Delay time elapsed, MIN output contacts 16/18 closed, 17/18 open.

MAX alarm		
Switchpoint for MAX water level reached or exceeded.	MAX LED flashes red	De-energizing delay in progress.
	MAX LED lights up red	Delay time elapsed, MAX output contacts 21/23 closed, 22/23 open.

Check function of MIN/MAX output contacts

Test of MIN alarm and MAX alarm		
Action	Display	Function
In operating mode: Water level between MIN and MAX Select parameter test. Press and hold push-button.	MAX LED flashes red	De-energizing delay in progress.
	MAX LED lights up red for 3 seconds	MAX output contact 21/23 closed, 22/23 open.
	The MIN and MAX LED do not light up for 1 second	MIN output contact 16/18 open, 17/18 open. MAX output contact 21/23 open, 22/23 closed.
	MIN LED flashes red	De-energizing delay in progress.
	MIN LED lights up red for 3 seconds	MIN output contact 16/18 closed, 17/18 open.
Test complete, release push-button. Device switches to operating mode.	Note: If you continue holding the push-button, the test sequence will start again. You can interrupt the test sequence at any time by releasing the push-button.	
Turn the rotary knob until the actual value is displayed. Or after 30s, the actual value is displayed automatically.		



Note

The actual value is shown on the 7-segment display.

Fault indications and troubleshooting

Display, diagnosis and troubleshooting



Important

Please check the following before fault diagnosis:

Supply voltage:

Is the level switch supplied with the voltage specified on the name plate?

Wiring:

Does the wiring conform to the wiring diagram?

Faults indicated by the 7-segment display		
Fault code	Fault	Remedy
E.005	Faulty level electrode, measuring voltage < 0.5 VDC	Check level electrode and replace if necessary. Check electrical connection.
	Faulty level transmitter, measuring current < 4 mA	Check level transmitter and replace if necessary. Check electrical connection.
E.006	Faulty level electrode, measuring voltage > 7 VDC	Check level electrode and replace if necessary. Check electrical connection.
	Faulty level transmitter, measuring current > 20 mA	Check level transmitter and replace if necessary. Check electrical connection.
E.012	Lower and upper ends of measuring range changed around	Reset measuring range
E.013	MIN switchpoint higher than MAX switchpoint	Reset switchpoints
In the event of a malfunction, the MIN and MAX alarm is triggered.		



Important

- For further diagnosis, please refer to the NRG 21-.. NRG 26-21 and NRGT 26-. installation & operating manual.



Note

In the event of a level controller malfunction, the MIN and MAX alarm is triggered and the equipment restarts.

If the process is continually repeated, the equipment must be replaced.

Further information

Action against high-frequency interference

High-frequency interference can be caused by out-of-phase switching operations. If such interference occurs and results in sporadic failure, we recommend taking the following action to suppress interference:

- Provide inductive loads with RC combinations as per manufacturer's specifications.
- Route the connecting cable to the level electrode or level transmitter separately from power lines.
- Increase the distance from sources of interference.
- Check the connection of the screen to the central earthing point (CEP) in the control cabinet.
- Suppress HF interference using hinged-shell ferrite rings.

Replacing/taking the equipment out of service

- Switch off the power supply and **cut off power to the equipment.**
- Remove the upper and lower terminal strips. **Fig. 8**
 - Insert a screwdriver between the terminal strip and the front frame, to the right and left of the arrow markings.
 - Release the terminal strip on the right and left sides, by turning the screwdriver in the direction of the arrow.
 - Remove the terminal strips.
- Release the white sliding fixture at the bottom of the housing and take the device off the support rail

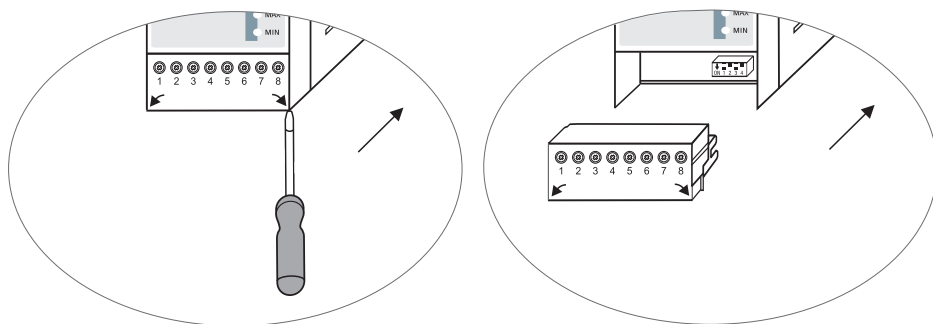

Fig. 8

Disposal

The equipment must be disposed of in accordance with statutory waste disposal provisions.

In the event of faults that cannot be remedied with the aid of this manual, please contact our Technical Customer Service.

For your notes

For your notes

For your notes



Agencies all over the world: www.gestra.de

GESTRA AG

Münchener Straße 77

28215 Bremen

Germany

Telefon +49 421 3503-0

Telefax +49 421 3503-393

E-mail info@de.gestra.com

Web www.gestra.de