



Level Switch

# **NRS 1-53**

**EN**  
English

Original Installation Instructions  
**819177-01**

# Contents

Page

## Important Notes

Usage for the intended purpose .....	4
Function .....	4
Safety note .....	4

## Directives and Standards

VdTÜV Bulletin "Wasserstand 100" (= Water Level 100) .....	5
LV (Low Voltage) Directive and EMC (Electromagnetic Compatibility) .....	5
ATEX (Atmosphère Explosible) .....	5
Note on the Declaration of Conformity / Declaration by the Manufacturer <b>CE</b> .....	5

## Technical data

NRS 1-53 .....	6 – 7
Scope of supply .....	7

## In control cabinet: Mounting level switch

Dimensions NRS 1-53 .....	8
Key .....	8
Installation in control cabinet .....	8
Name plate / marking .....	9

## In control cabinet: Wiring level switch

Wiring diagram for level switch NRS 1-53 .....	10
Key .....	10
Connecting supply voltage .....	11
Connecting MIN 1 / MIN 2 output contact .....	11
Connecting level electrode .....	11
Tools .....	11

## In the plant: Wiring level electrode

Connecting several level electrodes .....	12
Key .....	12
Examples of configuration NRS 1-53 / NRS 1-54, connection of several level electrodes .....	13
Connection of level electrode .....	14

# Contents - continued -

Page

## Factory settings

Factory setting ..... 14

## Commissioning procedure

Changing response sensitivity ..... 15

Checking switchpoint and function ..... 16,17

## Operation, alarm and test

Indications and operation ..... 18

## Further notes

Protection against high frequency interference ..... 19

Decommissioning / replacing the equipment ..... 19

Disposal ..... 19

## Important Notes

### Usage for the intended purpose

The level switch NRS 1-53 in conjunction with level electrodes NRG 1.-.. and ER 5. is used as limit switch, for instance in steam boiler and (pressurized) hot-water installations. The level switch detects and indicates two low water levels (MIN 1, MIN 2).

The level switch NRS 1-53 can be used in combination with the following level electrodes:

Level electrodes				
NRG 10-52, electrode with 4 rods	NRG 16-52, electrode with 4 rods	NRG 16-4, electrode with 1 rod	ER 50, electrode with 4 rods	ER 56, electrode with 4 rods

### Function

The operation of the level switch NRS 1-53 is based on the conductive measuring principle using the electrical conductivity of the water for signalling water level. The level switch is designed for different electrical conductivities and for connecting two level electrodes.

If two electrode rods are associated and connected to the level switch, two different low water levels (MIN 1 / MIN 2) can be detected and signalled. The length of the electrode rods determines the corresponding switchpoints.

As soon as the water falls below the preset low level (MIN 1 / MIN 2), the level switch detects that the electrode rods are exposed. After the de-energizing delay the MIN 1 / MIN 2 output contact will be switched over. At the same time the LEDs for MIN 1 and MIN 2 change from green to red.

Even if only one electrode rod is connected, both output contacts will be switched over after the de-energizing delay and the LEDs change from green to red.

When the equipment is used as water level limiter, the safety circuit for the heating is opened by the output contacts. The disconnection of the heating is interlocked in the external safety circuit and can only be deactivated when the water level is sufficiently high.

By pressing the Test button, MIN 1 and MIN 2 alarms can be simulated.

### Safety note

The equipment fulfils a safety function and must only be installed, wired and commissioned by qualified and competent staff.

Retrofitting and maintenance work must only be performed by qualified staff who - through adequate training - have achieved a recognised level of competence.



#### Danger

The terminal strips of the equipment are live during operation.

This presents the danger of electric shock!

**Always cut off power supply** to the equipment before mounting, removing or connecting the terminal strips!



#### Attention

The name plate specifies the technical features of the equipment. Note that any piece of equipment without its specific name plate must neither be commissioned nor operated.

## Directives and Standards

### VdTÜV Bulletin “Wasserstand 100” (= Water Level 100)

The level switch NRS 1-53 in conjunction with level electrodes NRG 10-52, NRG 16-52, NRG 16-4 and ER 5.-1 is type approved to VdTÜV Bulletin “Water Level 100”. The VdTÜV Bulletin “Wasserstand (= Water Level) 100” specifies the requirements made on water level control and limiting equipment for boilers.

### LV (Low Voltage) Directive and EMC (Electromagnetic Compatibility)

The equipment meets the requirements of the Low Voltage Directive 2014/35/EU and the EMC Directive 2014/30/EU.

### ATEX (Atmosphère Explosible)

According to the European Directive 2014/34/EU the equipment must **not** be used in explosion risk areas.



#### Note

The level electrodes NRG 10-52, NRG 16-52, NRG 16-4 and ER 5.-1 are simple items of electrical equipment as specified in EN 60079-11 section 5.7. According to the European Directive 2014/34/EU the equipment must be equipped with approved Zener barriers if used in potentially explosive areas.

Applicable in Ex zones 1, 2 (1999/92/EC).

The equipment does not bear an Ex marking.

### Note on the Declaration of Conformity / Declaration by the Manufacturer C€

For details on the conformity of our equipment according to the European Directives see our Declaration of Conformity or our Declaration of Manufacturer.

The current Declaration of Conformity / Declaration of Manufacturer are available in the Internet under [www.gestra.com/documents](http://www.gestra.com/documents) or can be requested from us.

## Technical data

### NRS 1-53

#### Supply voltage

24 VDC +/- 20 %

#### Fuse

external 0.5 A (semi-delay)

#### Power consumption

2 VA

#### Connection of level electrode

2 inputs for level electrode NRG 10-52, NRG 16-52, NRG 16-4 and ER 5.-1,

4 poles with screen

#### Electrode voltage

5 V<sub>SS</sub>

#### Response sensitivity (Electrical conductivity of water at 25 °C)

> 0.5 ... < 1000 µS/cm or > 10 ... < 10 000 µS/cm (switch-selectable)

#### Outputs

2 volt-free change-over contacts, 8 A 250 V AC / 30 V DC cos φ = 1.

De-energizing delay: 3 sec.

Provide inductive loads with RC combinations according to manufacturer's specification to ensure interference suppression.

#### Indicators and adjustors

1 pushbutton "Test" for simulating MIN 1 / MIN 2 alarm,

2 red/green LEDs for indicating operating mode and MIN 1 / MIN 2 alarm,

1 green LED indicating "Power ON",

1 code switch with 4 poles for changing the sensitivity

#### Housing

Housing material: base: polycarbonate, black; front: polycarbonate, grey

Conductor size: 1 x 4.0 mm<sup>2</sup> solid per wire or

1 x 2.5 mm<sup>2</sup> per stranded wire with sleeve to DIN 46228 or

2 x 1.4 mm<sup>2</sup> per stranded wire with sleeve to DIN 46228;

Terminal strips can be detached

Fixing of housing: Mounting clip on supporting rail TH 35, EN 60715

#### Electrical Safety

Pollution degree 2 for installation in control cabinet with protection IP 54, completely insulated

#### Protection

Housing: IP 40 to EN 60529

Terminal strip: IP 20 to EN 60529

#### Weight

approx. 0.2 kg

## Technical Data - continued -

### NRS 1-53 - continued -

#### **Ambient temperature**

when system is switched on: 0 ° .... 55 °C, during operation: -10 ... 55 °C

#### **Transport temperature**

-20 ... +80 °C (< 100 hours), defrosting time of the de-energized equipment before it can be put into operation: 24 hours.

#### **Storage temperature**

-20 ... +70 °C, defrosting time of the de-energized equipment before it can be put into operation: 24 hours.

#### **Relative humidity**

max. 95 %, no moisture condensation

#### **Approvals:**

TÜV certificate

VdTÜV Bulletin "Water Lever 100":

Requirements made on water level limiting & control equipment.

Type approval no. TÜV . WR/WB . XX-424

(see name plate)

### Scope of supply

#### **NRS 1-53**

1 Level switch NRS 1-53

1 Installation manual

## In control cabinet: Mounting level switch

### Dimensions NRS 1-53

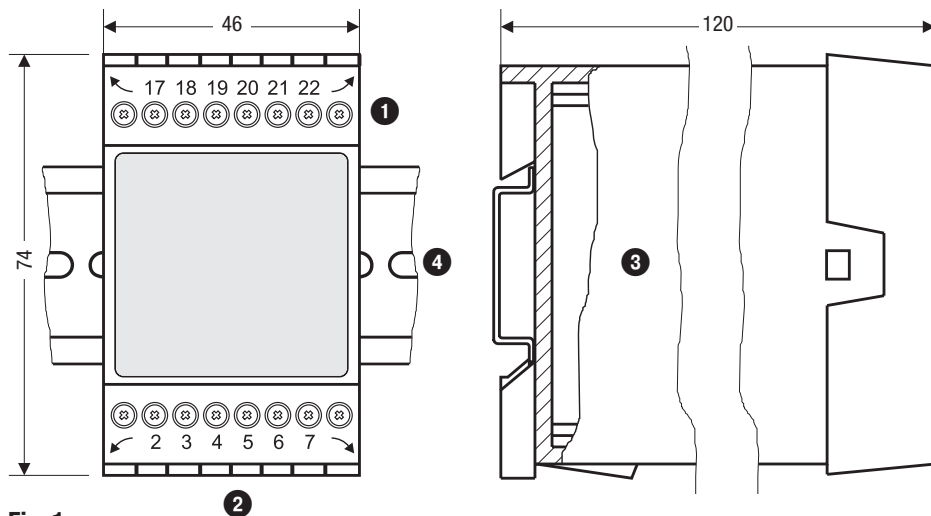

Fig. 1

### Key

- |                        |                                        |
|------------------------|----------------------------------------|
| 1 Upper terminal strip | 3 Housing                              |
| 2 Lower terminal strip | 4 Supporting rail type TH 35, EN 60715 |

### Installation in control cabinet

The level switch NRS 1-53 is clipped onto the support rail 4 type TH 35, EN 60715 in the control cabinet. Fig. 1



**Name plate / marking**

**Name plate (on top)**

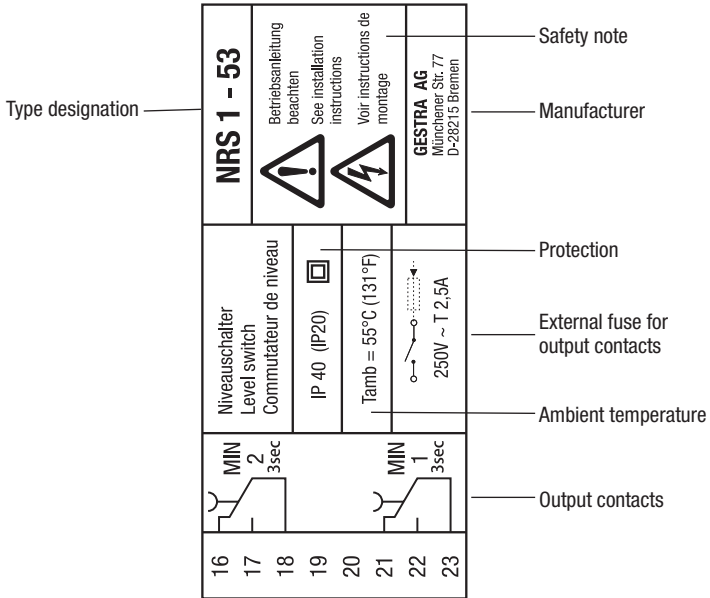

**Name plate (at the bottom)**

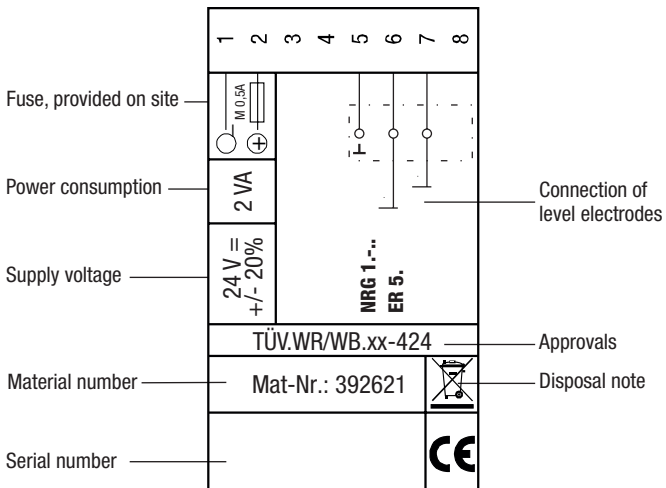

**Fig. 2**

## In control cabinet: Wiring level switch

### Wiring diagram for level switch NRS 1-53

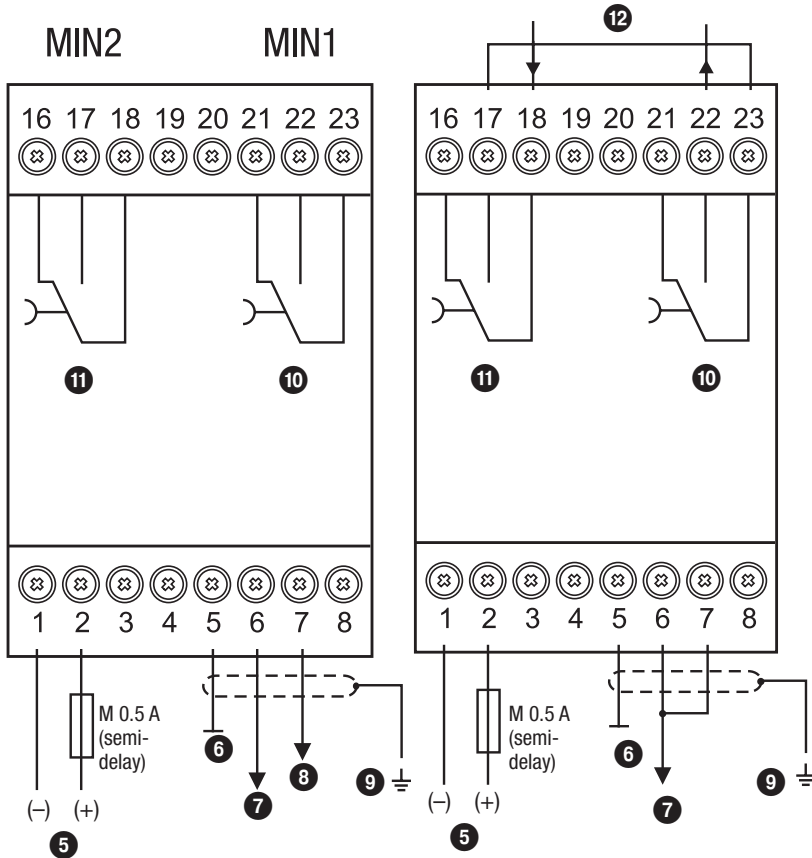

Fig. 3

### Key

- 5 Connection of supply voltage **24 V DC** with fuse 0.5 A (semi-delay) provided on site
- 6 Reference electrode or vessel used as functional earth
- 7 MIN 2 electrode rod or MIN electrode rod
- 8 MIN 1 electrode rod
- 9 Central earthing point (CEP) in control cabinet
- 10 MIN 1 output contact
- 11 MIN 2 output contact
- 12 Wire link, provided on site if only one electrode rod is used

## In control cabinet: Wiring level electrode - continued -

### Connecting supply voltage

The equipment is supplied with 24 V DC and fused with an external semi-delay fuse 0.5 A. Please use a safety power supply unit with safe electrical isolation.

The power supply unit must be electrically isolated from dangerous contact voltages and must meet at least the requirements on double or reinforced isolation according to one of the following standards: DIN EN 50178, DIN EN 61010-1, DIN EN 60730-1 or DIN EN 60950.

### Connecting MIN 1 / MIN 2 output contact

Wire the upper terminal strip **1** (terminals 16-18, 21-23) according to the desired switching functions. If only one electrode rod is used please connect the terminals 17 and 23 (safety circuit) and the terminals 6 and 7 with a wire link. **Fig. 3**

Provide an external slow-blow fuse 2.5 A for the output contacts.

When used as water level limiter the level switch NRS 1-53 does not interlock automatically when the water falls below the MIN level.

If an interlock function is required for the installation it must be provided in the follow-up circuitry (safety circuit). The circuitry must meet the requirements of the EN 50156.

When switching off inductive loads, voltage spikes are produced that may impair the operation of control and measuring systems. Connected inductive loads must be provided with suppressors such as RC combinations as specified by the manufacturer.

### Connecting level electrode

To connect the level electrode(s) use screened multi-core control cable with a min. conductor size 0.5 mm<sup>2</sup>, e. g. LiYCY 4 x 0.5 mm<sup>2</sup>, max. length: 100 m.

Wire terminal strip in accordance with the wiring diagram. **Fig. 3**.

Connect the screen **only once** to the central earthing point (CEP) in the control cabinet.

Make sure that connecting cables leading to the level electrodes are segregated and run separately from power cables.



#### Attention

- Do not use unused terminals as support point terminals.

### Tools

- Screwdriver for slotted screws, size 3.5 x 100 mm, completely insulated according to VDE 0680-1.

# In the plant: Wiring level electrode

## Connecting several level electrodes

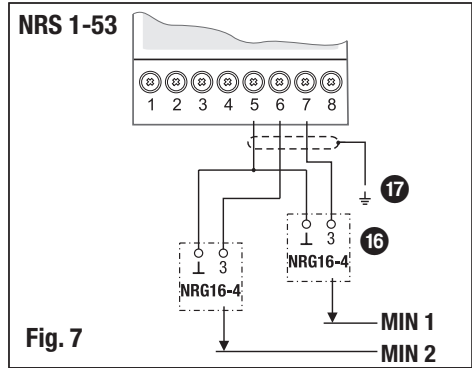
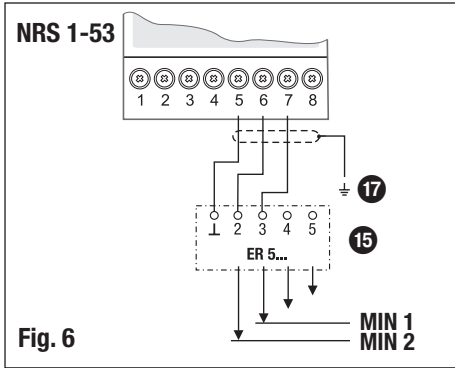
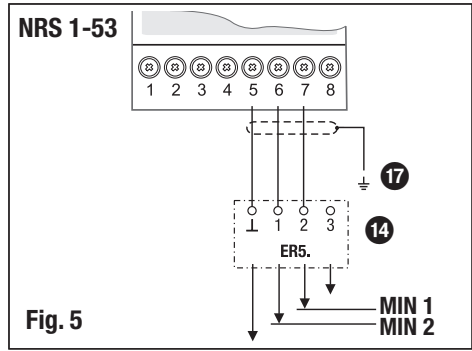
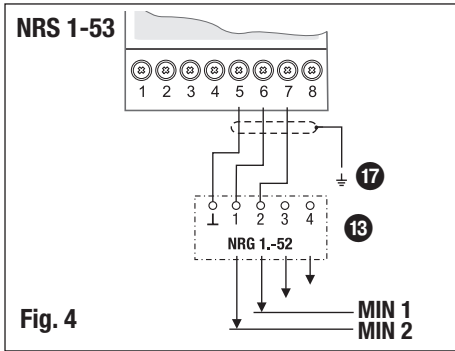

### Key

- 13 Level electrode NRG 10-52, NRG 16-52 with five-pole connector
- 14 Level electrode ER 5..., 4 pole connector
- 15 Level electrode ER 5..., 6 pole connector
- 16 Level electrode NRG 16-4
- 17 Central earthing point (CEP) in control cabinet

**Examples of configuration NRS 1-53 / NRS 1-54, connection of several level electrodes**

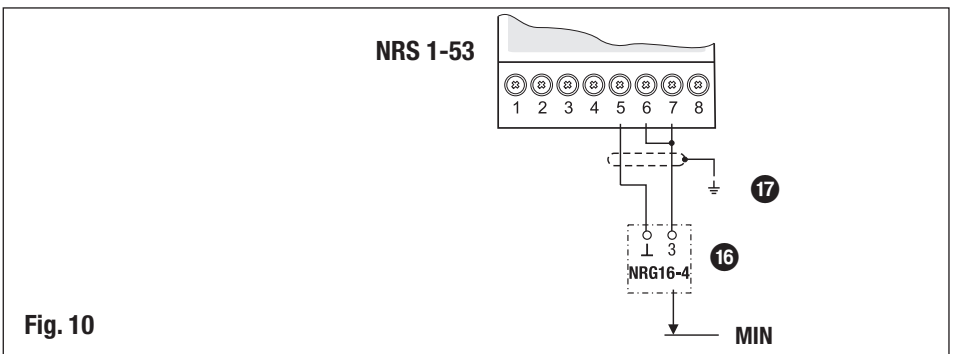
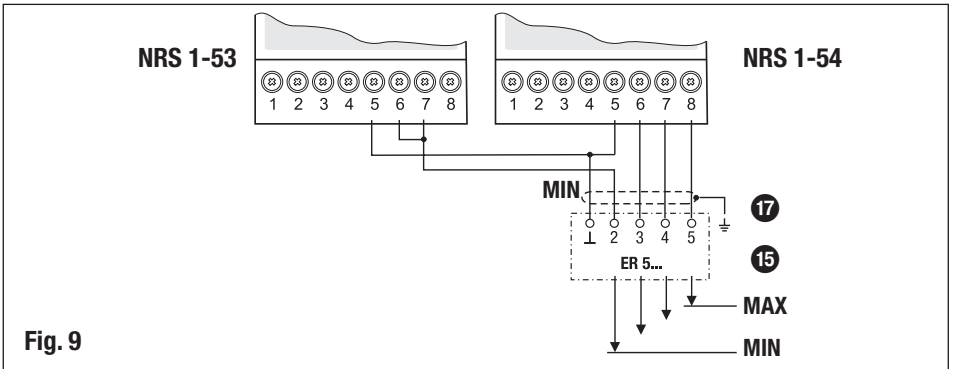
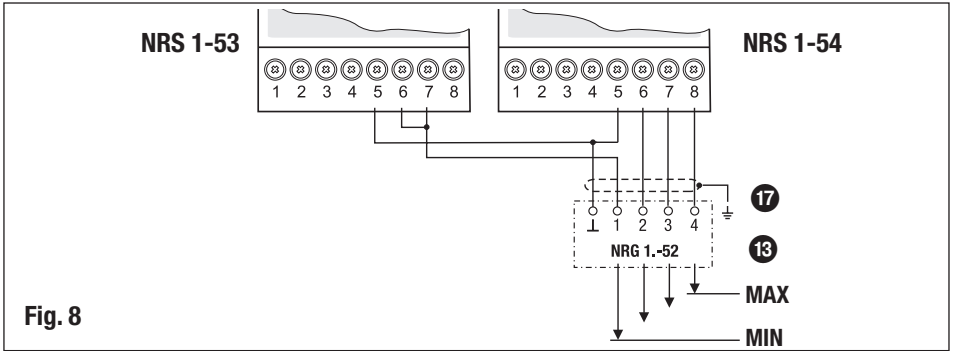

## In the plant: Wiring level electrode - continued -

### Connection of level electrode

The level switch NRS 1-53 can be used in combination with the following level electrodes:

Level electrodes				
NRG 10-52, electrode with 4 rods	NRG 16-52, electrode with 4 rods	NRG 16-4, electrode with 1 rod	ER 50, electrode with 4 rods	ER 56, electrode with 4 rods

To connect the level electrode(s) use screened multi-core control cable with a min. conductor size 0.5 mm<sup>2</sup>, e. g. LiYCY 4 x 0.5 mm<sup>2</sup>, max. length: 100 m.

Wire terminal strip in accordance with the examples **Fig. 4 to 10**.

Check the connection of the screen to the central earthing point (CEP) in the control cabinet.



#### Attention

- Please observe the instructions given in the installation & operating manual for the NRG 10-52, NRG 16-52, NRG 16-4 and ER 5.-1!
- Make sure that connecting cables leading to the level electrodes are segregated and run separately from power cables.

### Factory settings

#### Level switch NRS 1-53

The level switch features the following factory set default values:

- Response sensitivity: 10 μS/cm (at 25 °C)

## Commissioning procedure



### Danger

The terminal strips of the equipment are live during operation.

This presents the danger of electric shock!

Always **cut off power supply** to the equipment before mounting, removing or connecting the terminal strips!

## Changing response sensitivity

If the electrical conductivity of water is  $< 10 \mu\text{S}/\text{cm}$  at  $25^\circ\text{C}$  change the response sensitivity as follows:

- Cut off supply voltage.
- Remove **lower** terminal strip. **Fig. 10**
  - Insert a screwdriver to the right and left between the terminal strip and the front frame.
  - Unlock terminal strip on the left and right side. For this purpose move screwdriver in direction of the arrow .
  - Remove the terminal strip.
- Set switch S4 of code switch **18** to ON (= response sensitivity  $0.5 \mu\text{S}/\text{cm}$ ).
- Re-attach lower terminal strip.
- Apply supply voltage. Equipment is restarted.

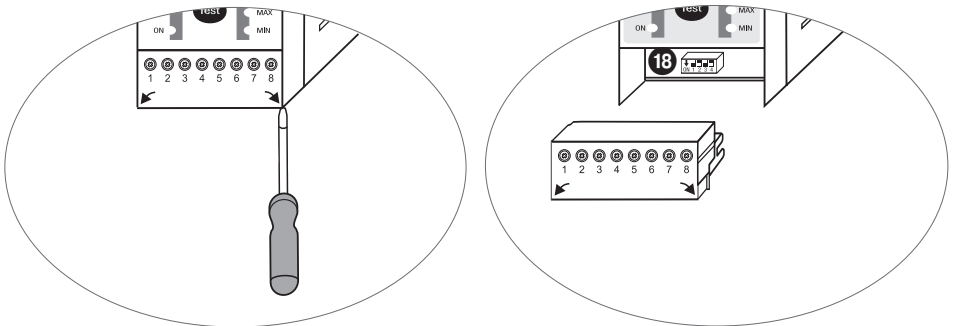

Fig. 11



Toggle switch, white

Fig. 12



### Attention

Do **not** change the code switch **18** settings of S1, S2 and S3!

## Checking switchpoint and function

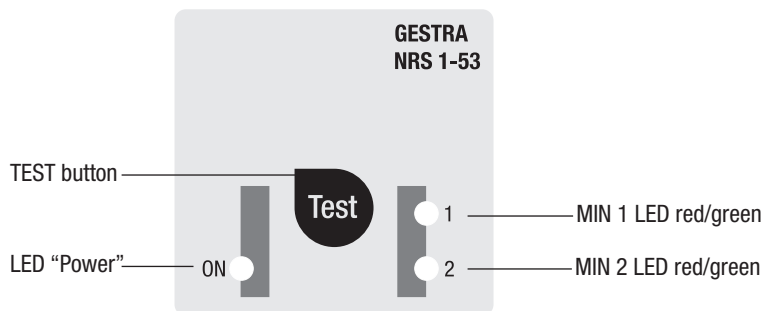

**Fig. 12**

<b>Start</b>		
<b>Activity</b>	<b>Display</b>	<b>Function</b>
Switch on supply voltage. Water level between MIN and MAX.	LED "Power" is illuminated.	
	LED MIN 1 / MIN 2 illuminated green.	MIN 1 / MIN 2 electrode rods submerged or MIN electrode rod submerged.
<b>Checking switchpoint and function (if 2 electrode rods are connected)</b>		
Lower water level until it is below MIN 1 level. MIN 1 electrode rod is exposed.	MIN 1 LED flashes red.	De-energizing delay is running.
	MIN 1 LED is illuminated red.	Time delay elapsed, MIN 1 output contact 21/23 closed, 22/23 open.
Lower water level until it is below MIN 2 level. MIN 2 electrode rod is exposed.	MIN 2 LED flashes red.	De-energizing delay is running.
	MIN 2 LED is illuminated red.	Time delay elapsed, MIN 2 output contact 16/18 closed, 17/18 open.
<b>Checking switchpoint and function (if 1 electrode rod is connected)</b>		
Lower water level until it is below MIN level. MIN electrode rod is exposed.	MIN 1 / MIN 2 LEDs are flashing red.	De-energizing delay is running.
	MIN 1 / MIN 2 LEDs are illuminated red.	Time delay elapsed, MIN 1 output contact 21/23 closed, 22/23 open, MIN 2 output contact 16/18 closed, 17/18 open.



## Checking switchpoint and function - continued -

Possible installation faults		
Status and indication	Error	Remedy
Water level below MIN 1/ MIN 2 switchpoint, MIN 1/ MIN 2 LED are illuminated green.	Electrode rods are too long.	Cut electrode rods to the length required for the MIN 1 / MIN 2 switchpoint or
	Electrode rod is too long.	Cut electrode rod to the length required for MIN switchpoint.
	If installed inside the boiler: Upper vent hole in protection tube does not exist or is obstructed.	Check installation of level electrode. Make sure that the level in the protection tube corresponds to the actual water level.
Water level between MIN and MAX. MIN 1 / MIN 2 LEDs are illuminated red.	Electrode rods are too short.	Replace level electrode and cut electrode rod(s) to the length dictated by MIN 1 / MIN 2 switchpoint.
	Electrode rod is too short.	Replace level electrode and cut electrode rod to the length dictated by MIN switchpoint.
	The earth connection to the vessel is interrupted.	Clean seating surfaces and screw in level electrode with metallic joint ring. Do not insulate the electrode with hemp or PTFE tape!
	Electrical conductivity of the boiler water too low.	Change response sensitivity to 0.5 $\mu\text{S}/\text{cm}$
	Upper vent hole flooded.	Check installation of level electrode. Make sure that the level in the protection tube corresponds to the actual water level.

Possible installation faults (only if 2 electrode rods are connected)		
Status and indication	Error	Remedy
No function. MIN and MAX LEDs are flashing simultaneously.	MIN 1 electrode rod is longer than MIN 2 electrode rod.	Check and change the electrical connection of the level electrode.

## Operation, Alarm and Test

### Indicators and adjustors

Operation		
Activity	Display	Function
Water level between MIN and MAX.	LEDs MIN 1 and MIN 2 are illuminated green.	MIN 1 output contact 21/23 open, 22/23 closed. MIN 2 output contact 16/18 open, 17/18 closed.

MIN 1 and MIN 2 alarm (if 2 electrode rods are connected)		
Water level below MIN 1 switchpoint.	MIN 1 LED flashes red.	De-energizing delay is running.
	MIN 1 LED is illuminated red.	Time delay elapsed, MIN 1 output contact 21/23 closed, 22/23 open.
Water level below MIN 2 switchpoint.	MIN 2 LED flashes red.	De-energizing delay is running.
	MIN 2 LED is illuminated red.	Time delay elapsed, MIN 2 output contact 16/18 closed, 17/18 open.

MIN alarm (if 1 electrode rod is connected)		
Water level below MIN switchpoint.	MIN 1 / MIN 2 LEDs are flashing red.	De-energizing delay is running.
	MIN 1 / MIN 2 LEDs are illuminated red.	Time delay elapsed, MIN 1 output contact 21/23 closed, 22/23 open, MIN 2 output contact 16/18 closed, 17/18 open.

Testing MIN 1 / MIN 2 alarm		
<b>During operation:</b> <b>Water level between MIN and MAX</b> Press and hold down button "Test".	MIN 1 LED flashes red.	De-energizing delay is running.
	MIN 1 LED is illuminated red for 3 sec.	MIN 1 output contact 21/23 closed, 22/23 open.
	MIN 1 and MIN 2 LEDs are illuminated green for 1 sec.	MIN 1 output contact 21/23 open, 22/23 closed. MIN 2 output contact 16/18 open, 17/18 closed.
	MIN 2 LED flashes red.	De-energizing delay is running.
	MIN 2 LED is illuminated red for 3 sec.	MIN 2 output contact 16/18 closed, 17/18 open.
The test is finished. Release button "Test". Equipment returns to operating mode.	Note: If you continue to hold down the Test button, a new test is started. You can abort the test any moment by releasing the Test button.	

## Further Notes

### Action against high frequency interference

High-frequency interference can be caused by out-of-phase switching operations. Should sporadic failures or malfunctions occur take the following remedial actions in order to suppress interference:

- Provide inductive loads with RC combinations according to manufacturer's specification to ensure interference suppression.
- Increase the distance to sources of interference.
- Check the connection of the screen to the central earthing point (CEP) in the control cabinet.
- HF interference suppression by means of hinged-shell ferrite rings.
- Make sure that connecting cables leading to the level electrodes are segregated and run separately from power cables.

### Decommissioning / replacing the equipment

- Switch off supply voltage and **cut off power supply** to the equipment.
- Remove the lower and upper terminal strips. **Fig. 11.**
- Release the white fixing slide at the bottom of the equipment and take the equipment off the supporting rail.

### Disposal

For the disposal of the equipment observe the pertinent legal regulations concerning waste disposal.

If faults occur that are not listed above or cannot be corrected, please contact our service centre or authorized agency in your country.



Agencies all over the world: [www.gestra.de](http://www.gestra.de)

## **GESTRA AG**

Münchener Straße 77

28215 Bremen

Germany

Telefon +49 421 3503-0

Telefax +49 421 3503-393

E-mail [info@de.gestra.com](mailto:info@de.gestra.com)

Web [www.gestra.de](http://www.gestra.de)