



Level Switch

NRS 1-50

For **ONE** Electrode

EN
English

Original Installation Instructions
818987-06

Contents

Page

Application

Usage for the intended purpose	4
Function	4

Directives and Standards

Pressure Equipment Directive (PED) 2014/68/EU	5
Functional Safety acc. to IEC 61508	5
VdTÜV Bulletin "Wasserstand 100" (= Water Level 100)	5
Approvals for Marine Applications	5
LV (Low Voltage) Directive and EMC (Electromagnetic Compatibility)	5
Note on the Declaration of Conformity / Declaration by the Manufacturer CE	5
ATEX (Atmosphère Explosible)	6
UL/cUL (CSA) Approval	6

Functional Safety acc. to IEC 61508

Safety characteristics of the subsystem NRG 1...-50 / NRS 1-50	7
Terms and abbreviations	7
Determination of the Safety Integrity Level (SIL) for safety-related systems	8

Technical Data

NRS 1-50	9 – 10
Name plate / marking	11

Dimensions and Functional Elements

NRS 1-50	12
----------------	----

Important Notes

Safety note	13
Scope of supply	13

Installation

Mounting level switch NRS 1-50	14
--------------------------------------	----

Contents - continued -

Page

Electrical Connection

Supply voltage	14
Connection of level electrode	14
Connection of safety circuit.....	14
Connection of logic unit (standby input).....	14
Connection for signal output	15
Tools.....	15
Wiring diagram for level switch NRS 1-50.....	16
Schematic representations of arrangements	17
Explanatory notes to schematic representations.....	18

Basic Settings

Factory setting	19
-----------------------	----

Commissioning Procedure

Checking switchpoint and function	20
---	----

Operation, Alarm and Test

Indicators and adjustors.....	21
-------------------------------	----

Troubleshooting

Indication, diagnosis and remedy	21 – 22
--	---------

Checking level electrode

Measuring voltage across level switch.....	23
--	----

Further Notes

Action against high frequency interference	24
Interlock and interlock deactivation.....	24
Checking the switchpoints	24
Decommissioning / replacing level switch.....	24
Disposal.....	24

Application

Usage for the intended purpose

The level switch NRS 1-50 is used in conjunction with level electrode NRG 1...-.. to limit the water level in steam boilers and (pressurised) hot-water plants.

Water level limiters switch off the heating when the water level falls below the set minimum level (low water).

Depending on the specified directives or standards, the level switch NRS 1-50 is intended to be used in combination with the following level electrodes:

Level electrode NRG 1...-..					
PED Pressure Equipment Directive 2014/68/EU + Functional Safety IEC 61508 SIL 3	NRG 16-50	NRG 17-50	NRG 19-50	NRG 111-50	
PED Pressure Equipment Directive 2014/68/EU + VdTÜV Bulletin "Wasserstand 100" (= Water Level 100)	NRG 16-50 NRG 16-11	NRG 17-50 NRG 17-11	NRG 19-50 NRG 19-11	NRG 111-50 NRG 111-11	NRG 16-36
Marine applications, e.g. DNV/LR Directives	NRG 16-50S	NRG 16-11S	NRG 16-38S	NRG 16-39S	

Function

The level switch NRS 1-50 is designed for different electrical conductivities of the boiler water and for connecting one level electrode.

When the water level falls below the low level the level electrode is exposed and a low level alarm is triggered in the level switch. This switchpoint is determined by the length of the electrode rod (level electrode NRG 1...-50, NRG 1...-11, NRG 16-36).

After the de-energizing delay has elapsed, the two output contacts of the level switch will open the safety circuit for the heating. The switching-off of the heating is interlocked in the external safety circuit and can only be deactivated when the level electrode enters the water again.

In addition the signalling contact for external signalling devices closes instantaneously.

An alarm will also be raised if a malfunction occurs in the level electrode and/or the electrical connection.

If the level electrode is installed in an isolatable level pot outside the boiler, make sure that the connecting lines are rinsed regularly. During the rinsing process the water level cannot be measured in the level pot for 5 minutes. The level switch therefore bypasses the level electrode and monitors the rinsing and bypass time (standby input, controlled by the logic unit SRL 6-50).

If the connecting lines for steam ≥ 40 mm and water ≥ 100 mm, the installation is considered to be internal. In this case the rinsing processes do not have to be monitored.

An automatic self-testing routine monitors the safety functions in the level switch and the level electrode. In the event of a malfunction the safety circuit opens instantaneously and switches the heating off.

Alarm and error messages are indicated by LEDs and an alarm can be simulated by pressing the test button.

Directives and Standards

Pressure Equipment Directive (PED) 2014/68/EU

Water level limiters are safety accessories as defined in the Pressure Equipment Directive (PED). The level switch NRS 1-50 in conjunction with level electrode NRG 1...-50 and NRG 16-36 is EC type approved according to EN 12952/EN 12953. These Directives state, among other things, the requirements made on limiting systems and equipment for steam boiler plants and (pressurised) hot-water installations.

Functional Safety acc. to IEC 61508

The level switch NRS 1-50 is certified acc. to IEC 61508 only if used in combination with level electrode NRG 1...-50. This standard describes the functional safety of safety-related electrical/electronic/programmable electronic systems.

The equipment combination NRG 1...-50 + NRS 1-50 corresponds to a type B subsystem with Safety Integrity Level (SIL) 3.

VdTÜV Bulletin "Wasserstand 100" (= Water Level 100)

The level switch NRS 1-50 in conjunction with the level electrodes NRG 1...-50, NRG 1...-11 and NRG 16-36 is type approved according to the VdTÜV Bulletin "Water Level 100".

The VdTÜV Bulletin "Wasserstand (= Water Level) 100" specifies the requirements made on water level control and limiting equipment for boilers.

Approvals for Marine Applications

The level switch NRS 1-50 in conjunction with level electrodes NRG 16-50S/NRG 16-11S/NRG 16-38S and NRG 16-39S is approved for marine applications. See data sheet NRG 16-50S, NRG 16-38S and NRG 16-39S.

LV (Low Voltage) Directive and EMC (Electromagnetic Compatibility)

The level switch NRS 1-50 meets the requirements of the Low Voltage Directive 2014/35/EU and the EMC Directive 2014/30/EU.

Note on the Declaration of Conformity / Declaration by the Manufacturer C€

For details on the conformity of our equipment according to the European Directives see our Declaration of Conformity or our Declaration of Manufacturer.

The current Declaration of Conformity / Declaration of Manufacturer are available in the Internet under www.gestra.en/documents or can be requested from us.

Directives and Standards - continued -

ATEX (Atmosphère Explosible)

According to the European Directive 2014/34/EU the level switch NRS 1-50 must **not** be used in potentially explosive areas.



Note

The level electrodes NRG 1...-50, NRG 1...-11 and NRG 16-36 are simple items of electrical equipment as specified in EN 60079-11 section 5.7. According to the European Directive 2014/34/EU the equipment must be equipped with approved Zener barriers if used in potentially explosive areas. Applicable in Ex zones 1, 2 (1999/92/EC). The equipment does not bear an Ex marking.

Note that the requirements of the IEC 61508 are not met if the NRG 1...-50, NRG 1...-11 and NRG 16-36 + Zener barriers + NRS 1-50 are interconnected!

UL/cUL (CSA) Approval

The equipment meets the requirements of Directives: UL 508 and CSA C22.2 No. 14-13, Standards for Industrial Control Equipment. File E243189.

Functional Safety acc. to IEC 61508

Safety characteristics of the subsystem NRG 1...-50 / NRS 1-50

The level switch NRS 1-50 is certified acc. to IEC 61508 if used in combination with level electrode NRG 1...-50.

The combination NRG 1...-50 + NRS 1-50 corresponds to a type B subsystem with Safety Integrity Level (SIL) 3. Type B means that the behaviour under fault conditions of the used components cannot be completely determined. The functional safety of the equipment combination refers to the detection and evaluation of the water level and, as a consequence, the contact position of the output relays.

The design of the equipment combination NRG 1...-50 + NRS 1-50 corresponds to the architecture 1oo2.

This architecture consists of two channels that detect and diagnose faults in each other. If a fault is detected, the equipment combination NRG 1...-50 + NRS 1-50 will go to the safe state, which means that the contacts of both output relays will open the safety circuit.

Safety characteristics	SIL	Architecture	Lifetime (a)	Proof Test Interval (a)
General	3	1oo2	20	20
	SFF	PFD_{av}	PFH_{av}	λ_{DU}
Level switch NRS 1-50 in conjunction with one or two level electrode(s)	>90 %	$<5 \times 10^{-4}$	$<5 \times 10^{-8}$	$<10 \times 10^{-8}/h$

Fig. 1

Terms and abbreviations

Terms Abbreviations	Description
Safety Integrity Level SIL	Classification of the Safety Integrity Level acc. to IEC 61508
Lifetime (a)	Functional safety: Lifetime in years
Safe Failure Fraction SFF	Percentage of failures without the potential to put the safety-related system into a dangerous state
Probability Failure per Demand (Low Demand) PFD _{av}	Average probability of failure on demand for low demand mode (once a year)
Probability Failure per Hour PFH _{av}	Probability of failure per hour
λ_{DU}	Failure rate for all dangerous undetected failures (per hour) of a channel of a subsystem

Fig. 2

Determination of the Safety Integrity Level (SIL) for safety-related systems

Level electrode, level switch and actuators (auxiliary contactor in safety circuit) are subsystems and together constitute a safety-related system that executes a safety function.

The specification of the safety-related characteristics **Fig. 1** refers to the level electrode and the level switch including the output contacts. The actuator (e. g. an auxiliary contactor in the safety circuit) is installation specific and, according to IEC 61508, must be considered separately for the whole safety-related system.

Table **Fig. 3** shows the dependence of the Safety Integrity Level (SIL) on the average probability of failure on demand of a safety function for the **whole** safety-related system (PFD_{sys}). The “Low demand mode” is here considered for a water level limiter, which means that the frequency of demands for operation of the safety-related system is no greater than one per year.

Low demand mode PFD_{sys}	Safety Integrity Level (SIL)
$\geq 10^{-5} \dots < 10^{-4}$	4
$\geq 10^{-4} \dots < 10^{-3}$	3
$\geq 10^{-3} \dots < 10^{-2}$	2
$\geq 10^{-2} \dots < 10^{-1}$	1

Fig. 3

The table in **Fig. 4** indicates the attainable Safety Integrity Level (SIL) as a function of the Safe Failure Fraction (SFF) and the Hardware Fault Tolerance (HFT) for safety-related systems.

Hardware Fault Tolerance (HFT) for type B			Safe Failure Fraction (SFF)
0	1	2	
	SIL 1	SIL 2	< 60 %
SIL 1	SIL 2	SIL 3	60 % – < 90 %
SIL 2	SIL 3	SIL 4	90 % – < 99 %
SIL 3	SIL 4	SIL 4	≥ 99 %

Fig. 4

Technical Data

NRS 1-50

Supply voltage

24 VDC + / - 20 %, 0.3 A;
100 – 240 VAC +10 / -15 %, 47 – 63 Hz, 0.2 A (optional)

External fuse

0.5 A (semi-delay)

Power consumption

7 VA

Response sensitivity (Electrical conductivity of water at 25 °C)

> 0,5 ... < 1000 μ S/cm or
> 10 ... < 10000 μ S/cm

Connection of level electrode

1 input for level electrode NRG 1...-50, NRG 1...-11, NRG 16-36, 4 poles, with screen.

Stand-by input

1 volt-free input, 24 V DC, for monitoring the purging and bypass time.
Max. bypass time: 5 minutes.

Safety circuit

2 volt-free make contacts, 6 A 250 V AC / 30 V DC $\cos \varphi = 1$.
Delay of response: 3 seconds, 15 sec. for marine applications.
Provide inductive loads with RC combinations according to manufacturer's specification to ensure interference suppression.

Signal output

1 volt-free output for instantaneous external signalling, 24 VDC, max. 100 mA (semiconductor output).

Indicators and adjustors

2 buttons for test and diagnosis,
2 red/green LEDs for indicating the operating mode and alarm.
3 red LEDs for diagnosis.

Housing

Housing material: base: polycarbonate, black; front: polycarbonate, grey.
Conductor size: 1 x 4.0 mm² solid per wire or
1 x 2.5 mm² per stranded wire with sleeve to DIN 46228 or
2 x 1.4 mm² per stranded wire with sleeve to DIN 46228;
terminal strips can be detached
Fixing of housing: Mounting clip on supporting rail TH 35, EN 60715

Electrical safety

Degree of contamination: 2, overvoltage category III to EN 61010-01.

Protection

Housing: IP 40 to EN 60529
Terminal strip: IP 20 to EN 60529

Weight

approx. 0.5 kg

NRS 1-50 - continued -

Ambient temperature

when system is switched on: 0 ° ... 55 °C

during operation: -10 ... 55 °C

Transport temperature

-20 ... +80 °C (< 100 hours), defrosting time of the de-energized equipment before it can be put into operation: 24 hours.

Storage temperature

-20 ... +70 °C, defrosting time of the de-energized equipment before it can be put into operation: 24 hours.

Relative humidity

max. 95 %, no moisture condensation





Site altitude

max. 2000 m

Approvals

EU Prototype approval	PED Pressure Equipment Directive 2014/68/EU EN 12952-11, EN 12953-09: Requirements made on limiting equipment for boilers
Functional safety SIL 3	IEC 61508: Functional safety of safety-related electrical/electronic/programmable electronic systems
TÜV type approval	VdTÜV Bulletin "Wasserstand 100" (= Water Level 100): Requirements made on water level limiting & control equipment Type approval no. TÜV.SWB.XX-422 (see nameplate)
Marine applications	Regulations of various classification societies

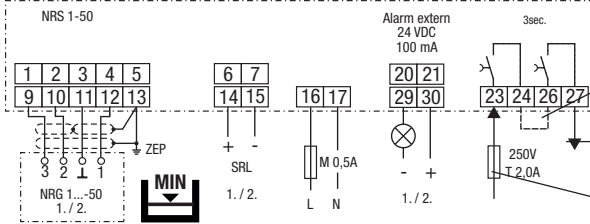
Name plate / marking

Safety note	 Betriebsanleitung beachten See installation instructions  Voir instructions de montage	Niveauschalter Level switch Commutateur de niveau			NRS 1-50			Type designation	
		100-240 V ~ -15 / +10%		7 VA	IP 40 (IP20)			Mains voltage/ Protection	
		Tamb = 55°C (131°F)		0,5 µS/cm			Ambient temperature / sensitivity		
Wiring diagram								Wire link, provided on site Safety circuit Fuse, provided on site	
	Funktionale Sicherheit Functional safety Sécurité fonctionnelle IEC 61508 SIL 3			Wasserstandbegrenzer Water level limiter Limiteur de niveau d'eau					Type-approval no.
Manufacturer	GESTRA AG Münchener Str. 77 D-28215 Bremen			Serial number					Disposal note
	TÜV . SWB . xx-422			0525					





Safety note	 Betriebsanleitung beachten See installation instructions  Voir instructions de montage	Niveauschalter Level switch Commutateur de niveau			NRS 1-50			Type designation	
		100-240 V ~ -15 / +10%		7 VA	IP 40 (IP20)			Mains voltage/ Protection	
		Tamb = 55°C (131°F)		10 µS/cm			Ambient temperature / sensitivity		
Wiring diagram								Wire link, provided on site Safety circuit Fuse, provided on site	
	Funktionale Sicherheit Functional safety Sécurité fonctionnelle IEC 61508 SIL 3			Wasserstandbegrenzer Water level limiter Limiteur de niveau d'eau					Type-approval no.
Manufacturer	GESTRA AG Münchener Str. 77 D-28215 Bremen			Serial number					Disposal note
	TÜV . SWB . xx-422			0525					

Fig. 5

Dimensions and Functional Elements

NRS 1-50

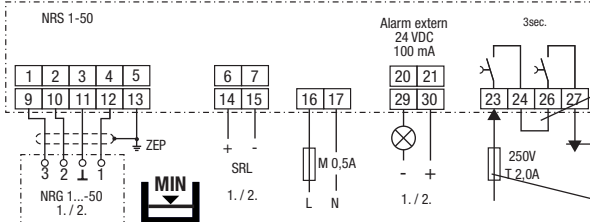
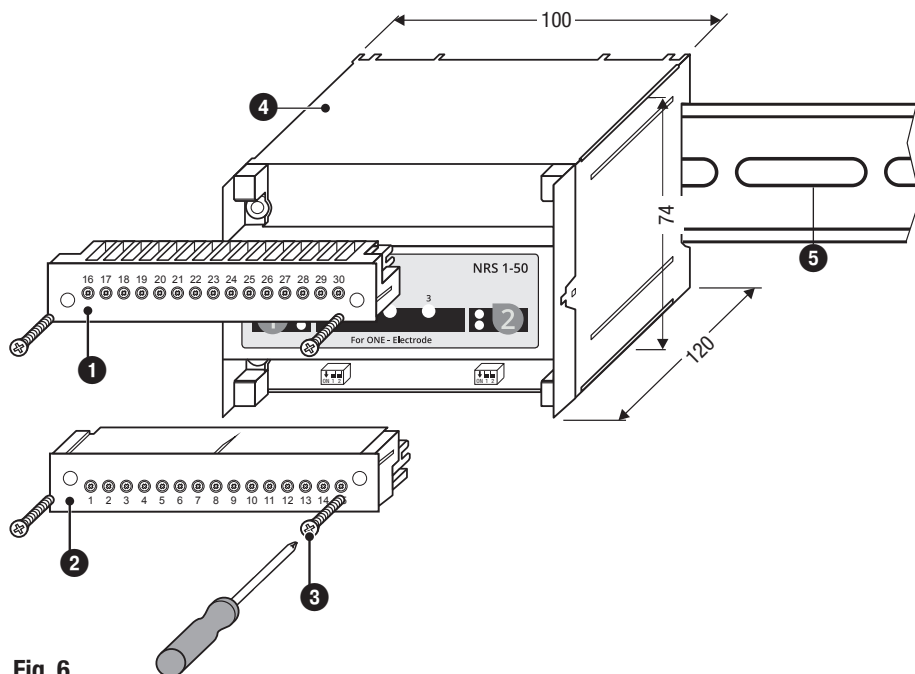

Fig. 6

Key

- ① Upper terminal strip
- ② Lower terminal strip
- ③ Fixing screws (cross recess head screws M3)
- ④ Enclosure
- ⑤ Supporting rail type TH 35, EN 60715

Important Notes

Safety note

This device is an item of equipment with safety function (PED) and must only be installed, wired and commissioned by qualified and competent staff.

Retrofitting and maintenance work must only be performed by qualified staff who – through adequate training – have achieved a recognised level of competence.



Danger

The terminal strips of the equipment are live during operation.

This presents the danger of electric shock!

Always **cut off power supply** to the equipment before mounting, removing or connecting the terminal strips!



Attention

The name plate specifies the technical features of the equipment. Note that any piece of equipment without its specific name plate must neither be commissioned nor operated.

Scope of supply

NRS 1-50

1 Level switch NRS 1-50

1 Installation manual

Installation

Mounting level switch NRS 1-50

The level switch NRS 1-50 is clipped onto the support rail type TH 35, EN 60715 in the control cabinet.
Fig. 6 

Electrical Connection

Supply voltage

Fuse the level switch NRS 1-50 with an external semi-delay fuse 0.5 A.

Connection of level electrode

To connect the level electrode please use:

- For level switch NRS 1-50 with response sensitivity 10 μ S:
Screened multi-core control cable, min. conductor size 0.5 mm², e.g. Li2YCY 4 x 0.5 mm²,
max. length 100 m.
- For level switch NRS 1-50 with response sensitivity 0.5 μ S:
Double-screened multi-core low-capacitance data cable, min. conductor size 0.5 mm²,
Li2YCY PiMF 2 x 2 x 0.5 mm², max. length 30 m.

Wire terminal strip in accordance with the wiring diagram. **Fig. 7**. Connect screen to terminal 5 and the central earthing point (**CEP**) in the control cabinet.

Connection of safety circuit

Connect the safety circuit for the heating to terminals 23, 24 and 26, 27. Wenn used as water level limiter according to TRD, EN 12952 / EN 12953 connect the output contacts of the two monitoring channels by adding a wire link between the terminals 24 and 26.

Fuse the output contacts with a 2 A or 1 A (for 72 hours operation acc. to TRD 604) slow-blow fuse.



Note

- In the event of an alarm the level switch NRS 1-50 does not interlock automatically. If an interlocking function in the installation is required, the follow-up circuit (safety circuit) must be equipped with an interlock. The circuitry must meet the requirements of the EN 50156.

Connection of logic unit (standby input)

For connecting the level switch with the logic unit use a control cable, e. g. 2 x 0.5 mm².
The control voltage must not exceed 36 V DC.

Connection for signal output

A signal output for the connection of further external signalling equipment is allocated to each monitoring channel in the level switch, max. load 100 mA. For connecting the level switch with the logic unit use a control cable, e. g. 2 x 0.5 mm². In the event of an alarm or error message the signal output (terminals 20, 21) opens instantaneously.



Danger

- For the supply of the level switch NRS 1-50 with 24 V DC use a safety extra-low voltage (SELV) power supply unit that must be electrically isolated from dangerous contact voltages and must meet at least the requirements on double or reinforced isolation acc. to DIN EN 50178 or DIN EN 61010-1 or DIN EN 60730-1 or DIN EN 60950 (safe isolation).
- Any item of equipment that you want to connect to terminals 6, 7 (standby input) must be certified to have at least double or reinforced isolation according to DIN EN 50178 or DIN EN 61010-1 or DIN EN 60730-1 or DIN EN 60950 (safe electrical isolation) between the standby inputs, the signal outputs and the live parts of the installation that are not supplied with safety extra-low voltage (SELV).



Attention

- Fuse the level switch NRS 1-50 with an external semi-delay fuse 0.5 A.
- Connect screen to terminal 5 and the central earthing point (**CEP**) in the control cabinet.
- To protect the switching contacts provide the safety circuit with a slow-blow fuse 2 A or 1.0 A (for 72 hrs. operation acc. to TRD 604).
- When switching off inductive loads, voltage spikes are produced that may impair the operation of control and measuring systems. Connected inductive loads must be provided with suppressors such as RC combinations as specified by the manufacturer.
- When used as water level limiter according to TRD, EN 12952 / EN 12953 connect terminals 24 and 26 by adding a wire link.
- Install connecting lines to level electrode and logic unit separated from power cables.
- Do not use unused terminals as support point terminals.

Tools

- Screwdriver for slotted screws, size 3.5 x 100 mm, completely insulated according to VDE 0680-1.

Wiring diagram for level switch NRS 1-50

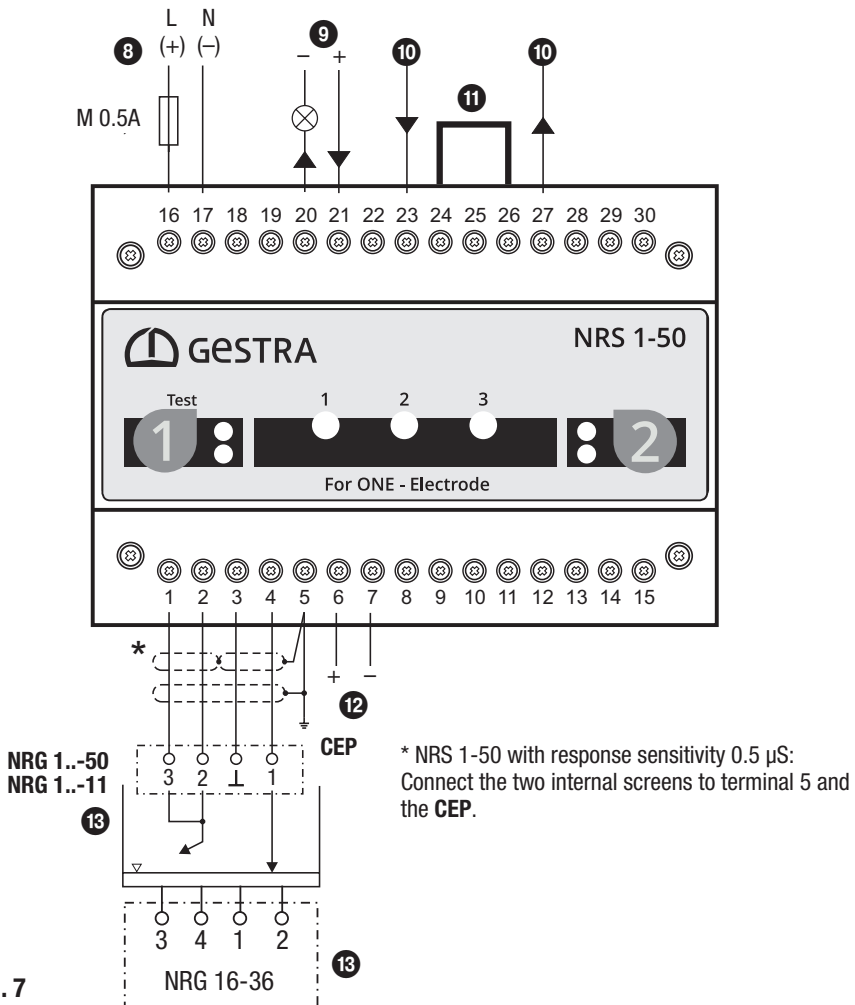
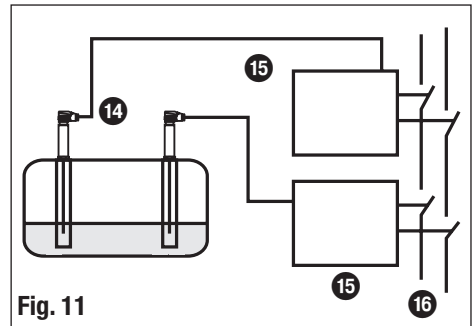
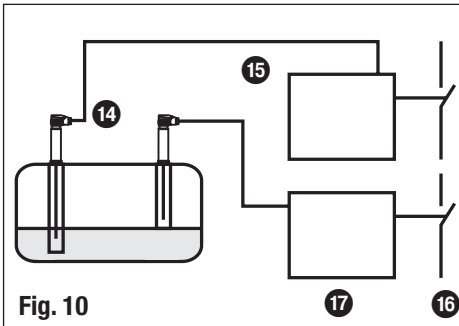
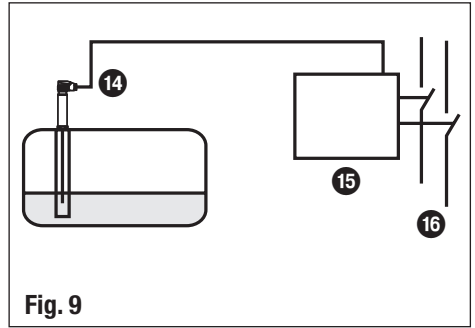
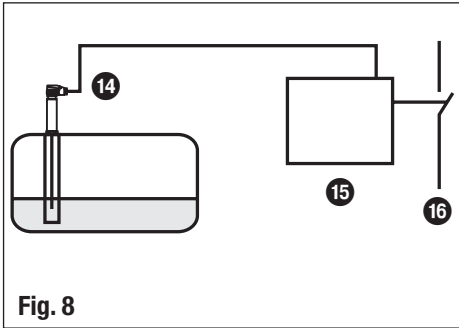

Fig. 7

Key

- 8** Supply voltage
 - 9** Signal output 1 for external alarm 24 V DC 100 mA (semiconductor output)
 - 10** Safety circuit, input and output
 - 11** Wire link, on site, when used as water level limiter acc. to TRD, EN 12952 / EN 12953
 - 12** Stand-by input, 24 V DC, for connecting the logic unit SRL 6-50
 - 13** Level electrode NRG 1...-50, NRG 1...-11 or NRG 16-36
- CEP** Central earthing point in control cabinet

Schematic representations of arrangements



Key

14 Level electrode NRG 1...-50

16 Safety circuit

15 Level switch NRS 1-50

17 Level switch NRS 1-50 for low-level pre-alarm

Explanatory notes to schematic representations

Steam boiler plants and (pressurized) hot-water installations according to TRD 604, EN 12952-07 / EN 12953-06, 72 h operation

Fig. 8

Combination consisting of 1 level electrode NRG 1...-50 and 1 level switch NRS 1-50 as water level limiter. Functional safety IEC 61508, SIL 3.

For operation according to TRD 604, EN 12952-07 / EN 12953-06 (72 hours), two independent and separate water level limiters must be used.

Hot water installations require two independent and separate water level limiters. For this purpose one equipment combination NRG 1...-50/NRS 1-50 shall be installed in the hot-water boiler and the second one in the pressure maintaining vessel, the expansion tank or the like (depending on the type of pressurization). For electrically heated steam boilers one water level limiter is sufficient.

Further applications in accordance with national sets of regulations

Fig. 9

Combination consisting of 1 level electrode NRG 1...-50 and 1 level switch NRS 1-50 as water level limiter. The level switch opens two separate safety circuits. Functional safety IEC 61508, SIL 3.

Fig. 10

Combination consisting of 1 level electrode NRG 1...-50 and 1 level switch NRS 1-50 as water level limiter and 1 level electrode NRG 1...-50 / 1 level switch NRS 1-50 as low-level pre-alarm. Functional safety IEC 61508, SIL 3.

Fig. 11

Combination consisting of 2 level electrodes NRG 1...-50 and 2 level switches NRS 1-50 as water level limiter. The level switch opens two separate safety circuits. Functional safety IEC 61508, SIL 3.

Basic Settings

Factory setting

Level Switch NRS 1-50

The level switch features the following factory set default values:

- De-energizing delay: 3 sec., 15 sec. for marine applications.

Commissioning Procedure



Danger

The terminal strips of the equipment are live during operation.

This presents the danger of electric shock!

Always cut off power supply to the equipment before mounting, removing or connecting the terminal strips!

Checking switchpoint and function

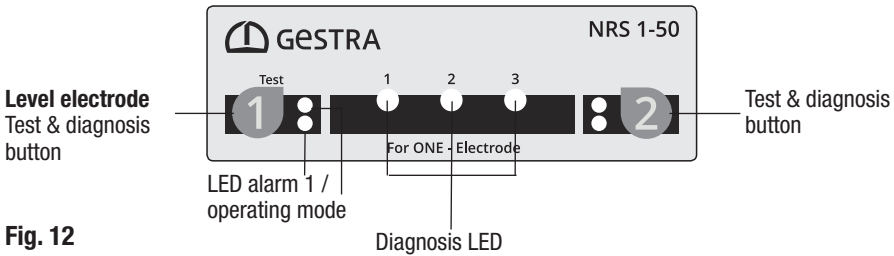

Fig. 12

Start		
Activity	Indication	Function
Apply mains voltage.	All LEDs are illuminated.	System is being started and tested, this takes approx. 10 sec. Output contacts are open. Signal output is closed.
	All LEDs are illuminated for more than 10 sec.	System malfunction. Possible causes: Faulty power supply, level switch defective.
Raise water in boiler until the switchpoint "low water level (LW)" is exceeded. Level electrode enters the water.	Green LED for level electrode is illuminated	Output contacts are closed. Signal output opens.

Checking switchpoint and function		
Lower water level until it is below the switchpoint "low water level (LW)". Level electrode is exposed.	Red LED for level electrode is flashing	De-energizing delay is running. Signal output is closed instantaneously.
	Red LED for level electrode is illuminated	Delay time has elapsed, output contacts open. Signal output is closed.

Possible installation faults		
Status and indication	Fault	Remedy
Sightglass indicates level below switchpoint "low water (LW)", red LED for level electrode not illuminated. Safety circuit closed.	Electrode rod is too long.	Cut electrode rod to the length dictated by the switchpoint LW.
	If installed inside the boiler: Upper vent hole in protection tube does not exist or is obstructed.	Check installation of level electrode. Make sure that the level in the protection tube corresponds to the actual water level.
Water level sufficient. Red LED for level electrode is illuminated. Safety circuit is open.	The electrode rod is too short.	Replace electrode rod and cut new rod to the length dictated by the switchpoint LW.
	The earth connection to the vessel is interrupted.	Clean seating surfaces and screw in level electrode with metallic joint ring. Do not insulate the electrode with hemp or PTFE tape!
	Electrical conductivity of the boiler water too low.	Set response sensitivity of the level switch to 0.5 μ S/cm.
	Upper vent hole flooded.	Check installation of level electrode. Make sure that the level in the protection tube corresponds to the actual water level.

Operation, Alarm and Test

Indicators and adjustors

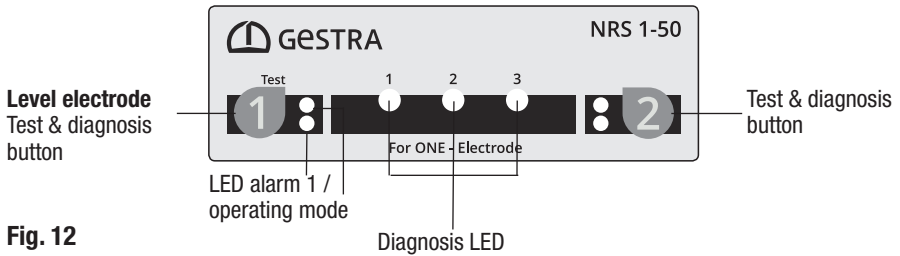

Fig. 12

Operation		
Activity	Indication	Function
Level electrode submerged.	Green LED for level electrode is illuminated	Output contacts are closed. Signal output opens.

Alarm		
Level electrode exposed, level below low water level (LW).	Red LED for level electrode is flashing	De-energizing delay is running. Signal output is closed instantaneously.
	Red LED for level electrode is illuminated	Delay time has elapsed, output contacts open. Signal output is closed.

Test channel 1		
During operation: Press and hold down key 1 until the end of the test, level switch must function as if there were an alarm.	Red LED for level electrode is flashing	Alarm simulated in channel 1. De-energizing delay is running. Signal output is closed instantaneously.
	Red LED for level electrode is illuminated	Delay time has elapsed, output contacts open. Signal output is closed. Test finished.
Replace level switch if the test was not finished successfully.		

Troubleshooting

Indication, diagnosis and remedy



Attention

Before carrying out the fault diagnosis please check:

Supply voltage:

Is the level switch supplied with the mains voltage specified on the name plate?

Wiring:

Is the wiring in accordance with the wiring diagram and the relevant schematic representation of arrangement?

Troubleshooting - continued -

Indication, diagnosis and remedy - continued -

Fault indication			
Status	Diagnosis	Function	Next activity
Faulty evaluation of level electrode, channel 1	Diagnosis LED 1 and LED alarm 1 illuminated.	Output contacts are opened instantaneously. Signal output closes instantaneously.	next: Press key 1 .
Malfunction in level switch detected.	Diagnosis LED 3 and LED alarm 1 or 2 illuminated.	Output contacts are opened instantaneously. Signal output is closed instantaneously.	next: Press key 1 or key 2 .

Diagnosis			
Display 1 and activity	Display 2	Fault	Remedy
LED alarm 1 and diagnosis LED 1 illuminated. Press and hold down key 1 .	Diagnosis LED 1 flashing.	Malfunction in level electrode, malfunction in level switch, faulty wiring, faulty measuring voltage.	<ul style="list-style-type: none"> - check wiring, - measure electrode voltages, - clean and, if necessary exchange level electrode, - exchange level switch.
	Diagnosis LED 2 flashing.	Malfunction in level electrode, malfunction in level switch, faulty wiring.	
	Diagnosis LED 3 flashing.	Interference voltage causing malfunction, boiler earth without PE	Provide screen and earthing, connect boiler with PE.
LED alarm 1 or 2 and Diagnosis LED 3 illuminated. Press and hold down key 1 or 2 .	Diagnosis LED 1 flashing.	Malfunction in processor, stand-by fault.	Observe operating instructions for the logic unit SRL. Replace level switch.
	Diagnosis LED 2 flashing.	Internal voltage fault.	Replace level switch.
	Diagnosis LED 3 flashing.	Malfunction in relay.	
Once the fault is eliminated, the level switch returns to normal operation.			
After elimination of the fault switch off the supply voltage and switch it on again after approx. 5 sec.			

If faults occur that are not listed above or cannot be corrected, please contact our service centre or authorized agency in your country.

Checking level electrode

Measuring voltage across level switch

Measure the electrode voltage across the level switch in order to check whether the level electrode is immersed or if there is a malfunction. Please observe **Fig. 13**.

U_{2-4}	U_{3-4}		U_{2-3}
	immersed	exposed	Malfunction (immersed/ alarm)
$\approx 0.7\text{ V}$ 85 Hz !	$< \frac{U_{2-4}}{2}$	$\geq \frac{U_{2-4}}{2}$	$\leq U_{3-4}$

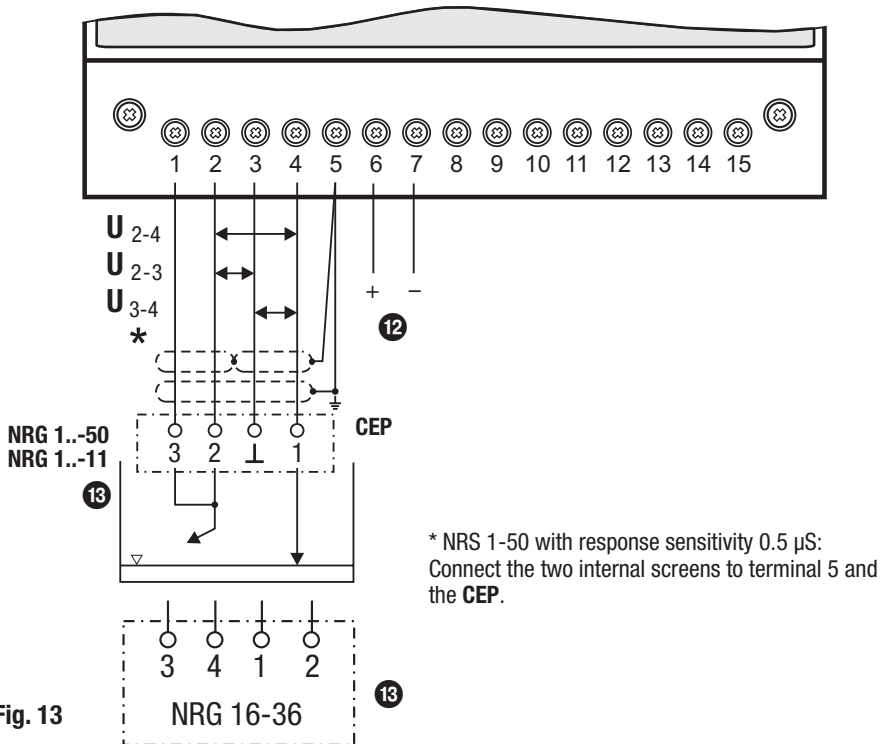

Fig. 13

Key

- 12** Stand-by input 1, 24 V DC, for connecting the logic unit SRL
- 13** Level electrode NRG 1...-50, NRG 1...-11, NRG 16-36
- CEP** Central earthing point in control cabinet



Note

- The self-checking routine of the level switch NRS 1-50 reduces U_{2-4} to 0 Volt, if executed cyclically.

Further Notes

Action against high frequency interference

Should sporadic failures occur in installations susceptible to faults (e. g. malfunctions due to out-of-phase switching operations) we recommend the following actions in order to suppress interferences:

- Provide inductive loads with RC combinations according to manufacturer's specification to ensure interference suppression.
- Make sure that connecting cables leading to the level electrodes are segregated and run separately from power cables
- Increase the distance to sources of interference.
- Check the connection of the screen to the central earthing point (CEP) in the control cabinet.
- HF interference suppression by means of hinged-shell ferrite rings.

Interlock and interlock deactivation

In the event of an alarm the level switch NRS 1-50 does not interlock automatically.

If a lock function is required by the installation it must be provided in the follow-up circuitry (safety circuit). The circuitry must meet the requirements of the EN 50156.

Checking the switchpoints

To check the switchpoint "Low water (LW)" you have to lower the water level. When the water level falls below the electrode tip, the level switch must activate an alarm and the safety circuit must open as soon as the de-energizing time delay has elapsed. The switching-off of the heating is interlocked in the safety circuit and can only be deactivated when the level electrode enters the water again. The LED for alarm 1 must be illuminated and no error must be indicated (LED for diagnosis not illuminated). Always check the switchpoint when commissioning the equipment, after replacing the level electrode and at regular intervals, e. g. every year.

Decommissioning / replacing level switch

- Switch off mains voltage and **cut off power supply** to the equipment.
- Unscrew the right and left fixing screws ③ and remove the upper and lower terminal strips ① ②, **Fig. 6**.
- Release the white fixing slide at the bottom of the equipment and take the equipment off the supporting rail.

Disposal

For the disposal of the levels switch observe the pertinent legal regulations concerning waste disposal.

For your notes

For your notes

For your notes



Agencies all over the world: www.gestra.de

GESTRA AG

Münchener Straße 77

28215 Bremen

Germany

Telefon +49 421 3503-0

Telefax +49 421 3503-393

E-mail info@de.gestra.com

Web www.gestra.de