



Oil Detector & Alarm

ORGS 11-1

ORGS 11-2

EN
English

Original Installation Instructions
810801-07

Contents

	Page
Usage for the intended purpose.....	4
Function	4
Safety note	4
Improper use	5
Application in potentially explosive areas	5
Design	5
Technical data	6
ORGS 11-2	6
Example name plate/identification.....	8
Installation	9
Installation requirements	9
Examples of installation	10
Dimensions ORGS 11-1	11
Key	11
Dimensions ORGS 11-2	12
ORGS 11-2	13
Tools.....	13
Key	13
Electrical connection.....	14
ORGS 11-1	14
Connection of measuring electrode ORGS 11-1	15
Connecting ORGS 11-1	15
Key	15
Tools.....	15
Wiring diagram for oil detector & alarm ORGS 11-1	16
Connecting oil detector & alarm ORGS 11-1 with supply voltage 24 / 115 / 230 V AC.....	16
Basic settings	17
Factory setting.....	17
Selecting the measuring range	17
Commissioning procedure	18
Applying supply voltage	18
Operating valves.....	18
Operation	18
Normal operation, oil alarm.....	18

Contents

Page

Troubleshooting	19
Safety note	19
Indication, diagnosis and remedy.....	19
Exchanging the electronic module	20
Removing and disposing of measuring electrode ORGS 11-1	21
Safety note	21
Removing and disposing of measuring electrode ORGS 11-1	21
Declaration of Conformity; standards and directives	22

Usage for the intended purpose

Use oil detector & alarm ORGS 11-2 only for signalling ingress of oil in cooling water systems.

Function

The **oil detector & alarm ORGS 11-2** is an equipment unit consisting of the measuring electrode ORGS 11-1 and a measuring pot.

The measuring electrode ORGS 11-1 is a compact-type system that comprises the measuring electrode and an electronic module integrated in the terminal box. The electrode operation is based on the conductive measuring principle using the electrical conductivity of the water for signalling water level. The electronic module detects whether the electrode rods are submerged or exposed and, in the event of ingress of oil, deactivates the output contacts.

A water sample, taken from the cooling water system downstream of the location at the highest point where ingress of oil might occur, is fed from below into the measuring pot of the ORGS 11-2. If the water is contaminated with oil, the oil droplets - due to their lower density - ascend and accumulate on top of the water and, consequently, the electrode rods are now submerged in this oil film.

Oil is not electrically conductive, which means that no current can flow between the electrode rods of the measuring electrode. In this case the oil detector & alarm will signal ingress of oil and trigger an alarm.

The amount of oil necessary to signal ingress of oil depends on the design of the measuring pot and the length of the electrode rods. The measuring pot is matched to the electrode such that ingress of oil is signalled when the oil content limit of approx. 50 ml is reached.

The equipment can detect all substances that are insoluble in water, not emulsified and lighter than water. In addition, the equipment can also detect all liquids with a conductivity value below the adjusted response sensitivity.

Safety note

The equipment must only be installed and commissioned by qualified and competent staff. Retrofitting and maintenance work must only be performed by qualified staff who - through adequate training - have achieved a recognised level of competence.



Danger

When loosening the measuring electrodes hot cooling water may escape.

This presents the risk of severe scalding all over the body!

Do not remove the measuring electrode ORGS 11-1 unless the boiler pressure is verified to be zero.

The terminal strip of the measuring electrode ORGS 11-1 is live during operation!
This presents the danger of electric shock!

Cut off power supply before mounting or removing the housing cover!



Attention

The name plate specifies the technical features of the equipment. Do not commission or operate any item of equipment that does not bear its specific name plate.

Improper use

Application in potentially explosive areas

The equipment must **not** be used in explosion-risk areas.



Attention

- Rust preventing oils, which are for instance emulsified in the cooling water, will not raise an alarm!

Design

ORGS 11-2:

Equipment module with three isolating valves and rapid-action deaerator, ready for connection. **Fig. 5**

ORGS 11-1:

Measuring electrode as spare part for equipment module ORGS 11-2 **Fig. 4**

Technical data

ORGS 11-2

Oil detector & alarm ORGS 11-2 (equipment unit)

Service pressure

6 bar

Service temperature

110 °C

Flow velocity

100 l/h to 300 l/h, recommended 200 l/h

Pressure drop Δp_v

0.06 bar (under test conditions)

Alarm

Raised when approx. 50 ml oil has accumulated

Water inlet, drain

Ball valve with E0-connection 15 L

Water outlet

Ball valve with E0-connection 12 L

Weight

approx. 7.4 kg

Measuring electrode ORGS 11-1 (component of ORGS 11-2)

Mechanical connection

Screwed G 1 A, ISO 228-1

Materials

Screw-in body: 1.4571, X6CrNiMoTi17-12-2

Electrode rods: 1.4571, X6CrNiMoTi17-12-2

Insulating sheath: PTFE

Terminal box: 3.2161 G AISi8Cu3

Supply voltage

230 V +/- 10 %, 50/60 Hz

115 V +/- 10 %, 50/60 Hz

24 V +/- 10 %, 50/60 Hz (optional)

Power consumption

5 VA

Fuse

external slow-blow 0.5 A

internal thermal fuse $T_{max} = 102\text{ °C}$

Response sensitivity

Range 1: 10 $\mu\text{S/cm}$

Range 2: 0.5 $\mu\text{S/cm}$

Code-switch selectable

Electrode voltage

10 V_{pp}

Technical data

ORGS 11-1 - continued -

Outputs for control circuit

2 volt-free change-over contacts,

8 A 250 V AC / 30 V DC $\cos \varphi = 1$

De-energizing delay: 3 sec.

Provide inductive loads with RC combinations according to manufacturer's specification to ensure interference suppression.

Indicators and adjusters

2 red LEDs indicating "Electrode submerged" and "Output relay energized" (no ingress of oil)

1 four-pole code switch for selecting the response sensitivity

Electrical connection

2 cable gland with integrated cable clamp M20 x 1.5

1 five-pole screw-type terminal strip, detachable, conductor size 1.5 mm²

Protection

IP 65 to DIN EN 60529

Max. admissible ambient temperature

Max. 70 °C

Storage and transport temperature

- 40 up to + 80 °C

Scope of supply

ORGS 11-2







1 Oil detector & alarm ORGS 11-2, PN 6

1 Measuring electrode ORGS 11-1 (mounted)

2 Sealing plugs for cable entry

1 Installation manual

Example name plate/identification

 Betriebsanleitung beachten! See installation instruction!  Vor dem Öffnen des Deckels Gerät freischalten! Before removing cover isolate from power supplies! 1	
2	
3	
4	5
6	7
	bar (psi) °C (°F)  Tamb = T °C (°F) 8
9	10
11	
L/H= 12	19
ppm 20	µS/cm 21
22	23
24	25
26	
13	
14 UK CA	15
EAC	CE
	
16 GESTAMP AG Münchener Str.77 28215 Bremen Made in Germany	
17	
18  12345678-12345678	

- 1 Safety note
- 2 Equipment designation
- 3 Equipment function
- 4 Nominal pressure rating
- 5 Connection thread
- 6 Material of screw-in thread
- 7 IP rating
- 8 Maximum pressure and temperature ratings
- 9 Power supply
- 10 Frequency in case of AC devices
- 11 Power consumption
- 12 Measuring range, length/height in mm
- 13 Component identification
- 14 Mark of conformity
- 15 Disposal information
- 16 Manufacturer
- 17 Protection class
- 18 Material number-serial number

Optional information

- 19 Cell constant in 1/cm
- 20 Measuring range in ppm
- 21 Measuring range in µS/cm
- 22 Hardware interface
- 23 Delay time
- 24 Additional data
- 25 Set limit with TRV (Tmax)
- 26 Cutout relay/specification of functional safety



 GESTRA		ORGS 11-2	
Oil Detector ORGS 11-2 with Electrode ORGS 11-1			
	6 bar (87 psi) 110 °C (230 °F) Flow Rate 100 – 300 l/h MADE BY GESTRA	DNV-GL	

Fig. 1

Installation

Installation requirements

The water sample taken from the cooling water system must flow continuously through the oil detector & alarm ORGS 11-2. We recommend a flowrate of 200 l/h.

The sampling of the cooling water should take place downstream of a potential oil leak at the highest point and, if possible, in a horizontal line. Since the oil flows in the upper part of the pipe we recommend the installation of a welding saddle according to DIN 2618 for collecting the oil droplets. The line leading to the measuring pot of the ORGS 11-2 should be vertically ascending, running directly into the bottom part of the measuring pot. Avoid any narrow parts in the supply line since they could give rise to undesired emulsification of the oil.

If space is a consideration and the measuring pot has to be installed at a lower point than the main cooling line make sure that the line leading to the measuring pot features sufficiently sized bends in order to prevent emulsification.

To achieve the recommended flowrate of approx. 200 l/h provide the main cooling water line with a standard orifice plate in order to throttle the flow velocity between the water sampling location and its re-entry point.

The pressure drop Δp_v across the measuring pot is **0.06 bar**.

The pressure drops of the connecting lines depend on the design and layout of the installation and must be ascertained individually. The calculated resistance coefficient ζ can be used to determine the opening ratio and, consequently, the required diameter "d" for the opening of the standard orifice plate.

For more information on the sizing and layout of fluid dynamic systems please refer to the corresponding technical literature and relevant standards.

Installation

Examples of installation

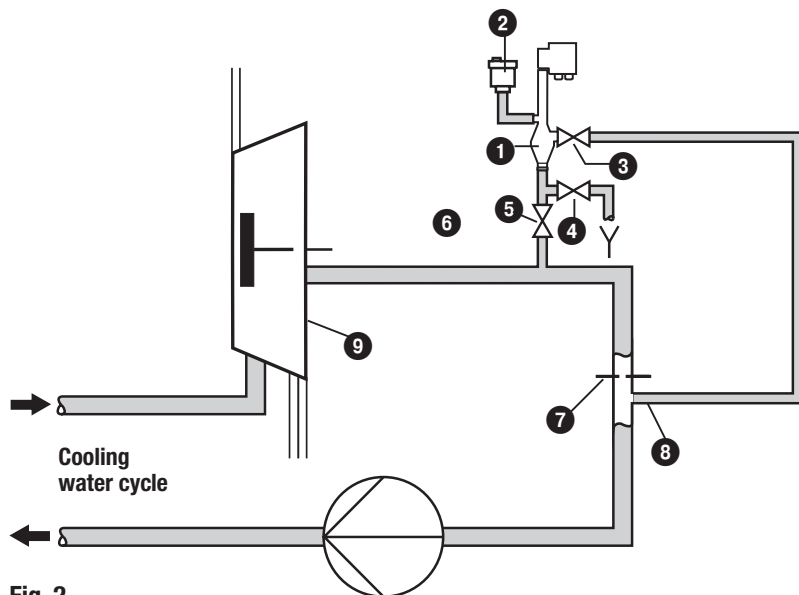

Fig. 2

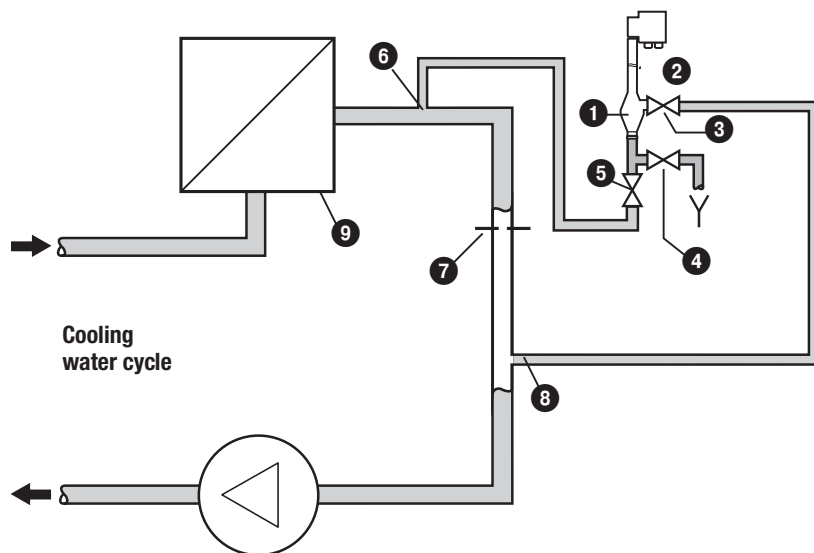

Fig. 3

Installation

Dimensions ORGS 11-1

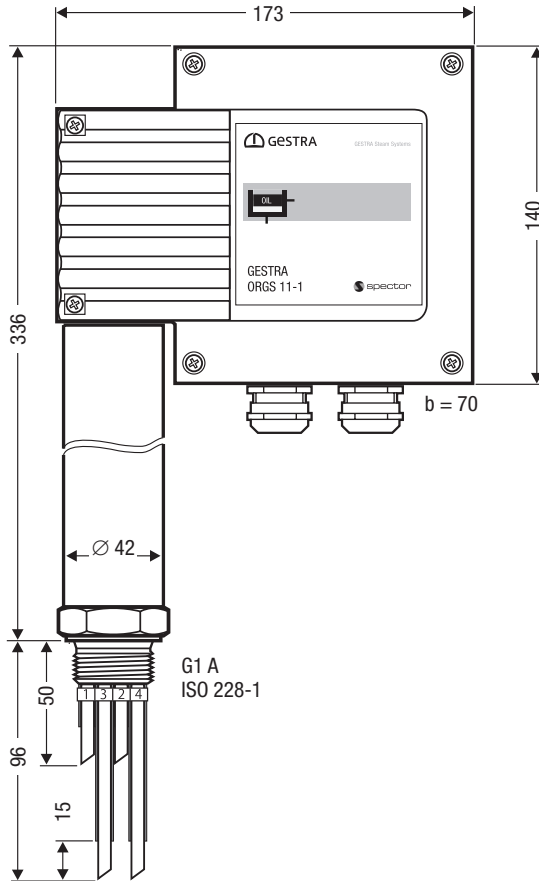

Fig. 4

Key

- | | |
|---|--|
| ① Oil detector & alarm ORGS 11-2 (equipment unit) | ⑥ Cooling water inlet DN 15 (outside \varnothing 20 mm) |
| ② Automatic rapid-action deaerator | ⑦ Standard orifice plate |
| ③ Cooling water outlet (ball valve DN 12 L, PN 500) | ⑧ Cooling water outlet DN 12 (outside \varnothing 16 mm) |
| ④ Drain (ball valve DN 15 L, PN 500) | ⑨ Main engine, diesel fuel, oil cooler, etc. |
| ⑤ Cooling water inlet (ball valve DN 15 L, PN 500) | |

Installation

ORGS 11-2

1. Use support flanges **11** to install the oil detector ORGS 11-2 in a suitable place.
2. Connect the supply line, the return line and the drain line with the progressive ring fitting of the ball valves in a pressure-tight manner.
3. Close ball valve **12** and open ball valves **13** and **14**. If the cooling water line is under pressure the rapid-action deaerator **15** will vent the ORGS 11-2.



Note

- Please refer to the examples of installation on page 10, **Fig. 2**, **Fig. 3**
- **Fig. 2** Recommended installation for an optimum arrangement of the measuring pot.
- **Fig. 3** Recommended installation if the measuring pot must be mounted at a lower point

Tools

- Open-end spanner A. F. 22, DIN 3110, ISO 3318
- Open-end spanner A. F. 27, DIN 3110, ISO 3318

Key

- | | |
|--|---|
| 10 Measuring electrode ORGS 11-1 | 13 Cooling water inlet (ball valve DN 15 L, PN 500) |
| 11 Support flange | 14 Cooling water outlet (ball valve DN 12 L, PN 500) |
| 12 Drain (ball valve DN 15 L, PN 500) | 15 Rapid-action deaerator |
| | 16 Sealing plug with lateral vent hole |

Electrical connection

ORGS 11-1

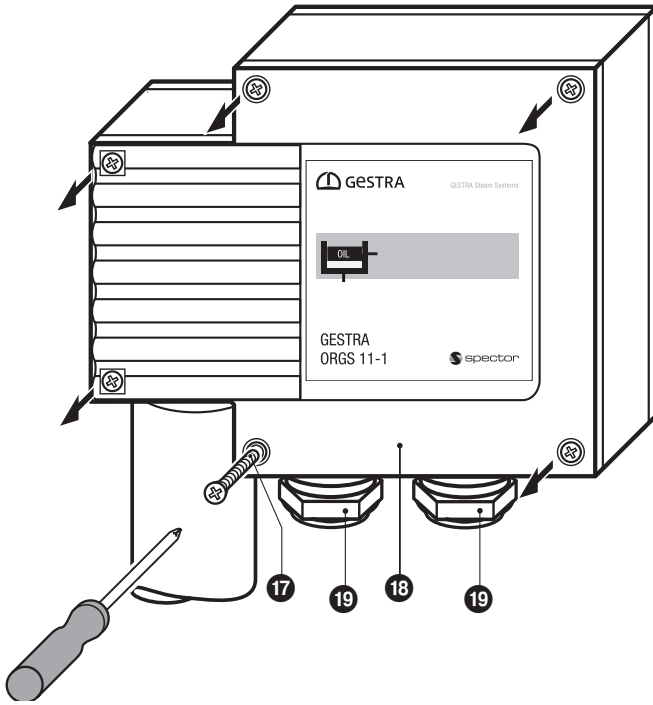

Fig. 6

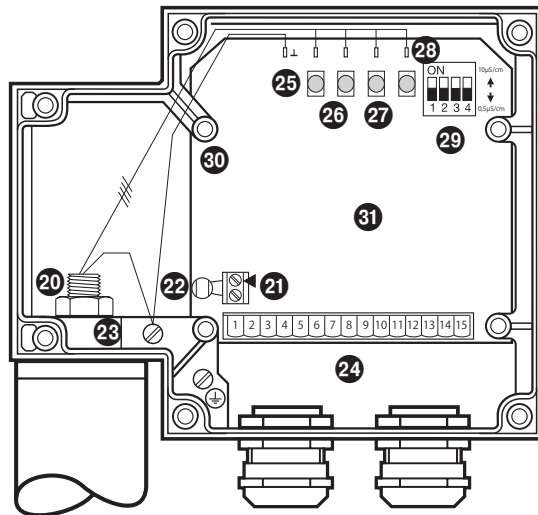

Fig. 7

Electrical connection

Connection of measuring electrode ORGS 11-1

A self-locking fixing nut 20 connects the terminal box to the electrode part. Before establishing the electrical connection you can turn the terminal box through max. +/- 180° into the desired direction (cable gland).

Connecting ORGS 11-1

1. Unscrew cover screws 17 and remove cover 18. Fig. 6
2. Detach terminal strip 24 from circuit board.
3. Strip off approx. 40 mm of cable insulation coating and remove approx. 5 mm of conductor end insulation.
4. Loosen cable glands 19. If the equipment is supplied with 24 V pull control cable through one of the cable glands. Seal off the unused cable gland (protection IP 65). If the equipment is supplied with 115 / 230 V pull the power cable through the right cable gland and the control cable through the left.
5. Connect the individual cables according to the wiring diagram to the terminal strip 23.
6. Re-attach terminal strip 24 to circuit board.
7. Tighten cable glands 19.
7. Mount cover 18 and fasten cover screws 17.



Attention

- The following relocations of cables with basic insulation are not permissible:
Mains and control cables in low voltage areas.

Key

- | | | | |
|----|--|----|--|
| 17 | Cover screws (cross recess head screws M4) | 25 | LED "Oil alarm" |
| 18 | Body cover | 26 | LED "Oil alarm" |
| 19 | Cable glands M 20 x 1.5 | 27 | LED without function |
| 20 | Fixing nut for terminal box | 28 | LED without function |
| 21 | Thermal fuse T _{MAX} 102 °C | 29 | Code switch for measuring range |
| 22 | Terminal strip for thermal fuse | 30 | Fixing screws for electronic module (4x) |
| 23 | Connection of functional earth | 31 | Electronic module |
| 24 | Terminal strip | | |

Tools

- Screwdriver, size 1
- Screwdriver, size 2.5, completely insulated according to EN IEC 60900

Electrical connection

Wiring diagram for oil detector & alarm ORGS 11-1

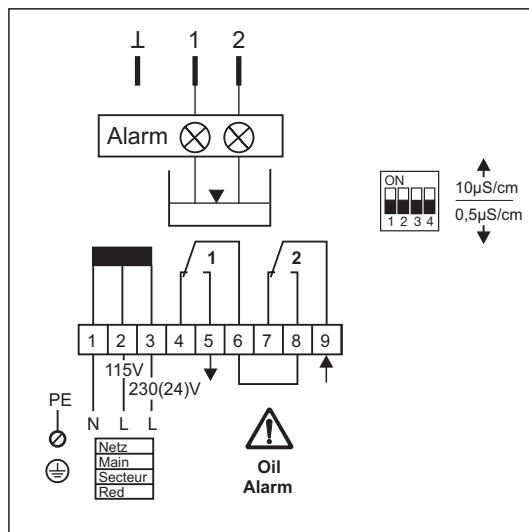

Fig. 8

Relays shown in power-off (alarm) position, LEDs 1 and 2 not illuminated!

Connecting oil detector & alarm ORGS 11-1 with supply voltage 24 / 115 / 230 V AC

Provide the oil detector & alarm with an external slow-blow fuse 0.5 A. To connect the supply voltage and the output contacts use multi-core control cables with a min. conductor size 1.5 mm², e. g. LiYCY .. x 1.5 mm².

Basic settings

Factory setting

The oil detector & alarm features the following factory set default values:

- Measuring range $\geq 10 \mu\text{S/cm}$

Selecting the measuring range

The measuring range can be switch-selected between $\geq 0.5 \mu\text{S/cm}$ and $\geq 10 \mu\text{S/cm}$ by means of a code switch 29 (toggle switch white):

1. Undo the cover screws 17 and take off the housing cover 18. **Fig. 6**

Code switch 1 – 4 OFF



Measuring range $\geq 0.5 \mu\text{S/cm}$.

Code switch 1 – 4 ON



Measuring range $\geq 10 \mu\text{S/cm}$.

2. Mount cover 18 and fasten cover screws 17.



Attention

- Do not damage the electronic components when setting the code switch!
- Do **not** use a pencil to set the code switch!

Commissioning procedure



Danger

The terminal strip of the oil detector & alarm is live during operation. This presents the danger of electric shock! Cut off power supply before mounting or removing the housing cover! Use only a completely insulated screwdriver according to EN IEC 60900 for setting the measuring points.

Applying supply voltage

1. Unscrew cover screws **17** and remove cover **18**. **Fig. 6**
2. Please check that the oil detector & alarm is wired in accordance with the wiring diagram (**Fig. 8** page 16) and switch on mains voltage.

Operating valves

3. Close ball valve **12** and open ball valves **13** and **14**. If the cooling water line is under pressure the rapid-action deaerator **15** will vent the ORGS 11-2.
4. If the measuring pot is vented and completely filled with cooling water the red LEDs **16** and **17** are illuminated.
5. Mount cover **18** and fasten cover screws **17**.

Operation

Normal operation, oil alarm

1. Under certain conditions air or gases that have been dissolved in the cooling water can accumulate in the upper part of the measuring pot. The rapid-action deaerator **15** will automatically vent the measuring pot during normal operation.
2. If oil accumulates in the upper part of the measuring pot and the electrode rods of the measuring electrode are completely covered with oil, an oil alarm will be raised and the LEDs **25** and **26** extinguish.
3. If an oil alarm has been triggered although there is no oil in the cooling water system, please refer to the troubleshooting notes on page 19.

Troubleshooting

Safety note

The equipment must only be installed and commissioned by qualified and competent staff. Retrofitting and maintenance work must only be performed by qualified staff who - through adequate training - have achieved a recognised level of competence.



Danger

The terminal strip of the measuring electrode ORGS 11-1 is live during operation!
This presents the danger of electric shock!
Cut off power supply before mounting or removing the housing cover!

Indication, diagnosis and remedy



Attention

Before carrying out the fault diagnosis please check:

Supply voltage:

Is the oil detector & alarm supplied with the mains voltage specified on the name plate?

Wiring:

Is the wiring in accordance with the wiring diagram?

Indication of malfunctions	
Oil alarm raised but no oil in cooling water system	
Error	Remedy
Power failure.	Switch on supply voltage. Check all electrical connections.
Air or gases that have been dissolved in the cooling water have accumulated in the measuring pot.	Check rapid-action deaerator and replace it if necessary .
The electrical conductivity is $\leq 10 \mu\text{S}/\text{cm}$.	Set code switch 29 to $0.5 \mu\text{S}/\text{cm}$. See Basic Settings
Thermal fuse 21 defective.	Discard and replace defective thermal fuse. Stock code no. 052433. Check ambient temperature, make sure that it does not exceed 70°C .
The earth connection to the vessel is interrupted.	Clean seating surfaces and screw in the oil detector & alarm together with the joint ring 33 x 39, form D, DIN 7603 (made from 1.4301), bright annealed. Do not insulate the electrode with hemp or PTFE tape!
The electronic module is faulty.	Replace electronic module.

Troubleshooting

Exchanging the electronic module

1. Unscrew cover screws ⑰ and remove cover ⑱. **Fig. 6**
2. Pull electrode wires from terminal lugs on circuit board. Remove the terminal strip ⑳.
3. Unscrew the fixing screws ㉑ for the electronic module ㉒ and remove the module. The module is available as spare part..
4. Install the new electronic module in reverse order.

Removing and disposing of measuring electrode ORGS 11-1

Safety note

The equipment must only be installed and commissioned by qualified and competent staff. Retrofitting and maintenance work must only be performed by qualified staff who - through adequate training - have achieved a recognised level of competence.



Danger

When loosening the measuring electrodes hot cooling water may escape.

This presents the risk of severe scalding all over the body!

Do not remove the measuring electrode ORGS 11-1 unless the boiler pressure is verified to be zero.

The terminal strip of the measuring electrode ORGS 11-1 is live during operation! This presents the danger of electric shock!

Cut off power supply before mounting or removing the housing cover!

Removing and disposing of measuring electrode ORGS 11-1

1. Close ball valves **13** and **14**.
2. Switch off supply voltage.
2. Undo cover screws **17** and remove the housing lid **18**.
3. Detach the connecting wires from the terminals **24** and pull wires out of the cable gland.
4. Before removing the equipment make sure that it is neither hot nor under pressure.

For the disposal of the measuring electrode observe the pertinent legal regulations concerning waste disposal.

If faults occur that are not listed above or cannot be corrected, please contact our service centre or authorized agency in your country.

Declaration of Conformity; standards and directives

You can find details on the conformity of the equipment and the applicable standards and directives in the Declaration of Conformity and associated certificates.

You can download the Declaration of Conformity from www.gestra.com and request relevant certificates by writing to the following address:

GESTRA AG

Münchener Straße 77

28215 Bremen

Germany

Tel. +49 421 3503 0

Fax +49 421 3503 393

E-mail info@de.gestra.com

Website www.gestra.com

Modifications to the equipment not approved by us will invalidate the Declarations of Conformity and certificates.

For your Notes



Agencies all over the world: www.gestra.com

GESTRA AG

Münchener Straße 77

28215 Bremen

Germany

Telefon +49 421 3503-0

Telefax +49 421 3503-393

E-mail info@de.gestra.com

Web www.gestra.com

UK Importer:

GESTRA UK Ltd

Unit 1 Sopwith Park, Royce Close,
West Portway Business Park, Andover,
Hampshire SP10 3TS
United Kingdom