



Operating Terminal & Display Unit

URB 1



CANopen

EN
English

Original Installation Instructions
810375-07

Contents

Page

Important Notes

Usage for the intended purpose	4
Safety note	4
Attention	4
LV (Low Voltage) Directive	4
EMC (Electromagnetic Compatibility)	4
ATEX (Atmosphère Explosible)	4

Explanatory Notes

Scope of supply	5
Description	5
Function	6
System components	6
Design	6

Technical Data

URB 1	7
Name plate/markings	8
Dimensions	9

Design

URB 1	10
Key	12

Functional Elements

URB 1	11
Key	12

Installation

URB 1	13
Tools	13
Example of Installation	13
Key	13

Electrical Connection

Control cable	14
Note	15
CAN bus voltage supply	15
Attention	15
Wiring diagram	16
Key	16

Contents – continued –

Page

Electrical Connection – continued –

CAN bus wiring diagram	17
Attention	17
Note	18
Tools	18

Basic Settings

Bus cable	18
Node ID	19
Factory setting	20
Establishing / changing node ID	20
Attention	20
Code switch settings	20

Commissioning Procedure

Applying mains voltage	21
Adjusting display contrast	21, 22
Changing factory set node ID of URB 1, adjusting / changing node ID of URB 1	23–25
Possibilities to display bus devices	25
Setting / changing node IDs of bus-based equipment	26–29
Visual display / parameterisation of bus-based equipment	30–35
0 % to 100 % calibration for capacitance level monitoring	36–38
Calibrating the feedback potentiometer of an external control valve	39–42
Establishing switchpoints and proportional coefficient Xp	43–46
Adjusting sensitivity range	47, 48
Setting relay energizing times	49–51
Adjusting conductivity controller	52–63
Adjusting linear (LIN) temperature compensation	64–66
Adjusting standard curve (NORM) temperature compensation	67–71
Enabling automatic (AUTO) temperature compensation	72, 73
Disabling temperature compensation	74, 75

Operation

Manual operation of an external control valve	76
Stand-by operation with the steam boiler disconnected	77

System Malfunctions

Systematic malfunction analysis	78
Fault finding list for troubleshooting	79, 80

Annex

Note on the Declaration of Conformity / Declaration by the Manufacturer CE	81
---	----

Important Notes

Usage for the intended purpose

Use operating terminal & display unit URB 1 only in conjunction with GESTRA Spector Bus systems (CANopen).

Safety note

The equipment must only be installed and commissioned by qualified and competent staff. Retrofitting and maintenance work must only be performed by qualified staff who – through adequate training – have achieved a recognised level of competence.



Attention

The name plate specifies the technical features of the equipment. Note that any piece of equipment without its specific name plate must neither be commissioned nor operated.

LV (Low Voltage) Directive

The equipment meets the requirements of the Low Voltage Directive 2014/35/EU.

EMC (Electromagnetic Compatibility)

The equipment meets the requirements of the EMC Directive 2014/30/EU.

ATEX (Atmosphère Explosible)

According to the European Directive 2014/34/EU the equipment must not be used in potentially explosive areas.

Explanatory Notes

Scope of supply

URB 1

- 1 Operating terminal & display unit URB 1 (in plastic case)
- 2 Fixing screws for panel mounting
- 1 Installation & operating manual

Description

The URB 1 is a user-friendly operating terminal and display unit for GESTRA CAN bus systems. The equipment makes retrieving and processing all standard functions of associated system components very easy. The URB 1 uses the CANopen protocol. In addition, the URB 1 simplifies the parameterisation procedure: The switchpoints, proportional band and response sensitivity can be adjusted by means of the keypad regardless of the actual level. The energizing and de-energizing times of the relays can be set individually for their respective switchpoints.

The following tables list the GESTRA systems that can be viewed by the URB 1.

Standard display	Level					Conductivity
	NRS 1-40	NRS 1-41	NRS 1-42	NRS 2-40	NRR 2-40	LRR 1-40
Actual value (bar chart)				●	●	●
Actual value (numerical)				●	●	●
Switchpoint (symbol)			●	●	●	●
High level alarm (electrode HW)			●	●	●	●
Low level alarm (electrode LW)			●	●	●	●
Manual/automatic operation				●	●	●
Stand-by mode						●
Unit [$\mu\text{S}/\text{cm}$], [ppm]						●
Low level limit	●					
High level limit		●				
Alarm (warning triangle) ⚠	●	●				

Further display information	Level					Conductivity
	NRS 1-40	NRS 1-41	NRS 1-42	NRS 2-40	NRR 2-40	LRR 1-40
Actual value (continuous)				●	●	●
Switchpoints			●	●	●	●
Setpoint					●	●
Deviation					●	●
Valve position					●	●
Intermittent blowdown duration						●
Intermittent blowdown interval						●
Purging pulse 24 h						●
Current CAN bus addresses	●	●	●	●	●	●

Explanatory Notes – continued –

Function

The URB 1 communicates with other GESTRA system components via CAN bus, using the CANopen protocol to DIN ISO 11898.

The URB 1 can also be used to operate and display further system components during operation.

- Capacitance level switch NRS 2-40 CANopen
- Level controller NRR 2-40 CANopen
- Conductivity level switch NRS 1-42 CANopen
- Low level limiter to TRD 604/EN NRS 1-40 CANopen
- High water limiter to TRD 604/EN NRS 1-41 CANopen
- Conductivity controller and limiter to TRD 604/EN LRR 1-40 CANopen

System components

NRS 1-40

Level switch NRS 1-40

NRS 1-41

Level switch NRS 1-41

NRS 1-42

Level switch NRS 1-42

NRS 2-40

Level switch NRS 2-40

NRR 2-40

Level switch NRR 2-40

LRR 1-40

Conductivity switch LRR 1-40

Design

URB 1

Enclosure of insulating material with terminals for installation in control cabinets.

The terminals are accessible from the back.

External dimensions: 95 x 95 x 63

Technical Data

URB 1

Type approval

TÜV · XX-399 (level)

TÜV · WÜL · XX-007 (conductivity)

Software

Software version 311099.16

Input

Power supply 18V to 36V DC

Interface for CAN bus using CANopen protocol to DIN ISO 11898

Output

Interface for CAN bus using CANopen protocol to DIN ISO 11898

Indicators and adjustors

1 illuminated graphic display, resolution 128 x 64 pixels

5 pushbuttons

1 three-pole code switch for baud rate setting

Supply voltage

18 V to 36 V DC

Protection

Front panel: IP 54 to DIN EN 60529

Back: IP 00 to DIN EN 60529

Admissible ambient temperature

0 – 55 °C

Body material

Front panel: Aluminium with polyester membrane

Casing: Noryl GFN 2 SE 1, glass-fibre reinforced

Weight

Approx. 0.3 kg

Name plate/markings

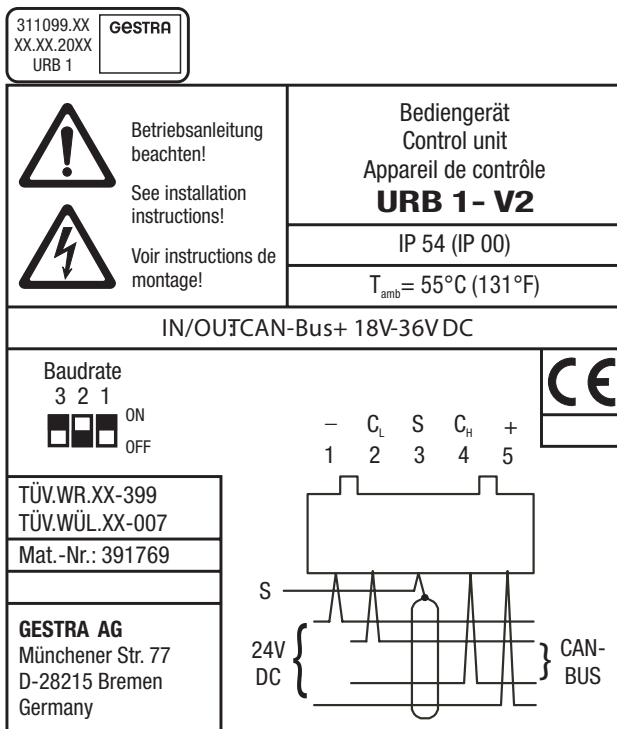

Fig. 1

Dimensions

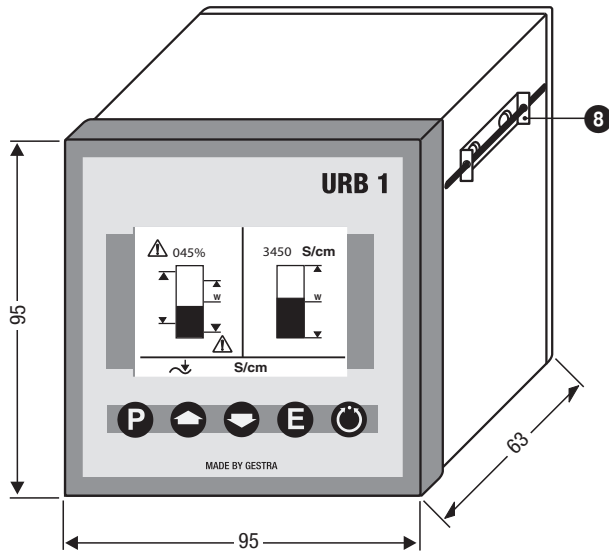

Fig. 2

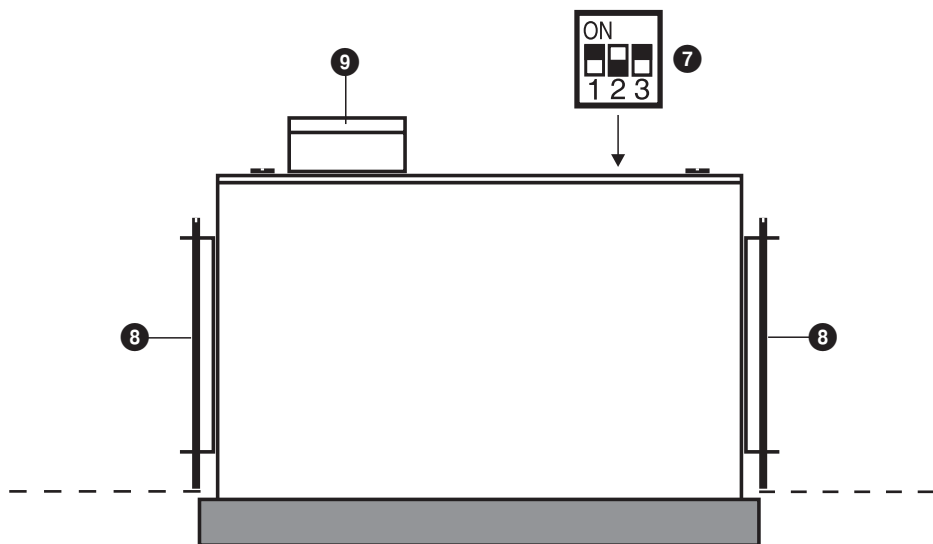

Fig. 3

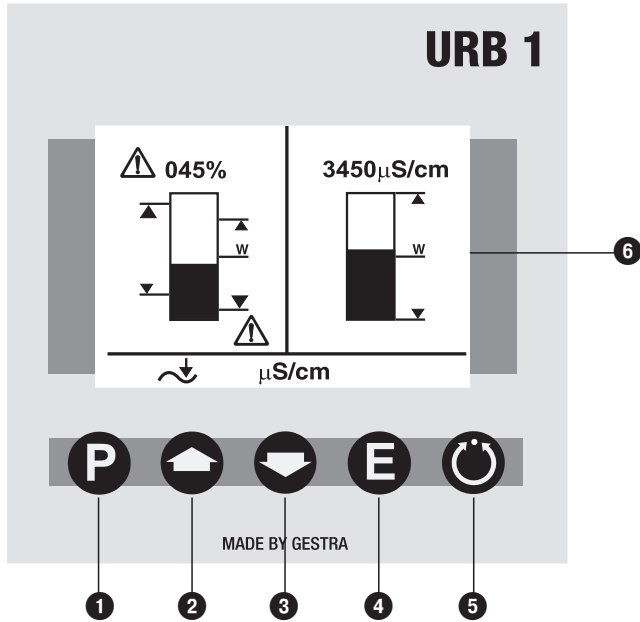

Fig. 4

Key

- ① Program button for switching between operating mode and parameterisation mode
- ② Increase button
- ③ Decrease button
- ④ Enter button
- ⑤ Manual / automatic button
- ⑥ Illuminated LCD display, resolution 128 x 64 Pixel
- ⑦ Code switch for baud rate setting
- ⑧ Fixing screws for panel mounting
- ⑨ 5-pole connector

Installation

URB 1

Panel mounting

1. Provide panel cut-out, dimensions: $92^{+0.8} \times 92^{+0.8}$.
2. Install URB 1 using the fixing clips supplied with the equipment.

Tools

- Screwdriver (5.5/100)

Example of Installation

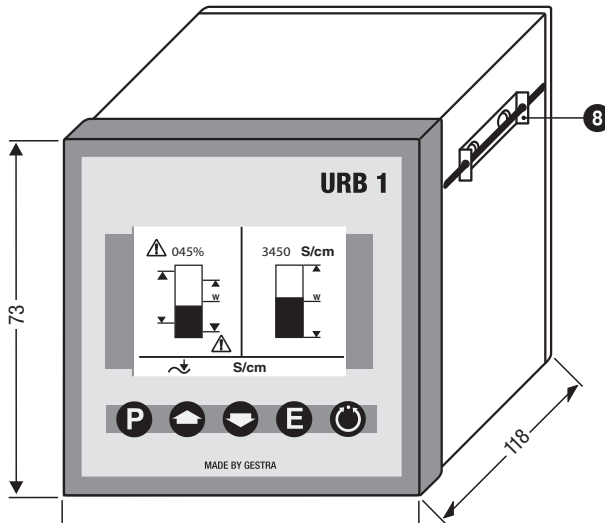

Fig. 5

Key

- 8 Fixing screw for panel mounting

Electrical Connection

Control cable

NRS, NRR, LRR, TRS, URB 1

To wire the equipment, multi-core twisted-pair control cable **must** be used for the bus line, e. g. UNITRONIC® BUS CAN 2 x 2 x ... mm² or RE-2YCYV-fl 2 x 2 x ... mm².

The baud rate (data transfer rate) dictates the cable length and size between the bus nodes. The total power consumption must also be taken into consideration when selecting the conductor size. The total power consumption is obtained from the number of bus nodes.

If the cable length between the steam boiler and the control cabinet exceeds 15 m, we recommend that you fit a branching box that is resistant to electromagnetic interference (stock code 1501214) and use a control cable with a larger conductor size for the distance to the control cabinet.

S 1	S 2	S 3	Baud rate	Cable length	Number of pairs and conductor size [mm ²]
OFF	ON	OFF	250 kBit/s	125 m	2 x 2 x 0.32
Factory setting					
ON	ON	OFF	125 kBit/s	250 m	2 x 2 x 0.5
OFF	OFF	ON	100 kBit/s	335 m	2 x 2 x 0.75
ON	OFF	ON	50 kBit/s	500 m	on request, depending on bus configuration
OFF	ON	ON	20 kBit/s	1,000 m	
ON	ON	ON	10 kBit/s	1,000 m	

Set baud rate via code switch ⑦. Make sure that all bus nodes feature the same settings.



Note

- The specified max. baud rates and cable lengths are based on empirical values obtained by GESTRA. In certain cases it may be necessary to reduce the baud rate in order to ensure operational safety.
- The type and design of the data cable has a strong influence on the electromagnetic compatibility (EMC) of the equipment. Take special care when connecting the equipment.
- If you do not use the control cable assemblies connect the connectors and jacks for the control cables as indicated in the assignment diagram for sensor plug-in unions.

CAN bus voltage supply

To ensure the troublefree operation of the CAN bus system make sure that the voltage supply for all bus devices is sufficient.

Please use the following table to check the voltage supply of your bus system.

Control units with voltage supply	Qty.	X	Power output per item	=	Sum
		X	6 W	=	W
Please enter data.			Sum 1	=	W
Sensor, transmitter, control units, operating & display unit URB 1	Qty.	X	Power consumption per item	=	Sum
		X	3 W	=	W
Operating & Display Unit URB 2		X	5 W	=	W
Please enter data.			Sum 2	=	W

If sum 2 exceeds sum 1 supply the CAN bus with 24 V DC coming from a separate and stabilized safety power supply unit (e. g. SITOP Smart 24 V 2.5 A).

The power supply unit must be electrically isolated from dangerous contact voltages and must meet at least the requirements on double or reinforced isolation acc. to DIN EN 50178 or DIN 61010-1 or DIN EN 60730-1 or DIN EN 60950 (safe isolation).

The power supply unit must be provided with an overcurrent protective device in accordance with EN 61010-1.



Attention

If a safety power supply unit (e. g. SITOP smart, 24 V, 2.5 A) is used for the voltage supply of the CAN bus do not tap the supply voltage from the terminals 1 and 5 of the GESTRA control devices.

Wiring diagram

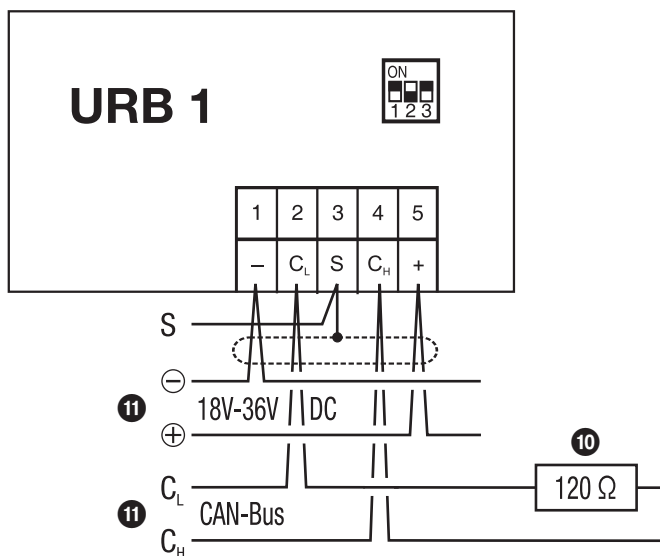

Fig. 6

Key

- 10** Terminating resistor 120 Ω, RES 1 or RES 2
- 11** CAN bus line, twisted pair control cable

CAN bus wiring diagram

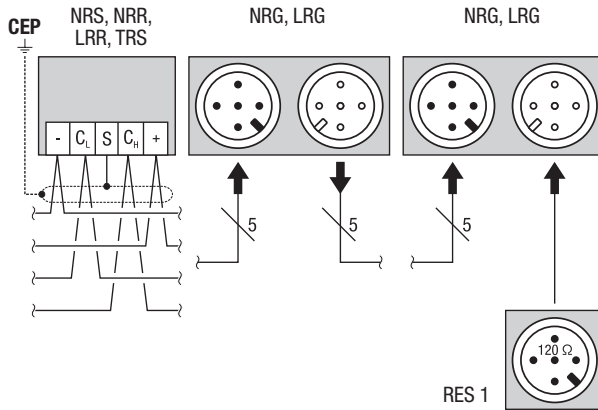

Fig. 7



Attention

- Wire equipment in series. Star-type wiring is not permitted!
- Link screens of control cables such that electrical continuity is ensured and connect them **once** to the central earthing point (CEP). If equipotential bonding currents are to be expected, for instance in outdoor installations, make sure that the screen is separated from the central earthing point (CEP).
- To protect the switching contacts fuse circuit with T 2.5 A or according to TRD regulations (1.0 A for 72 h operation).
- If two or more system components are connected in a CAN bus system, provide the first and the last device with a terminating resistor of 120 Ω.
- Note that in a CAN bus network only **one** water-level limiting system may be used.
- Do **not** interrupt the CAN bus network during operation with one or more system components!

If the CAN bus network is interrupted the safety circuit will be opened.

Before taking the CAN bus line from the terminal strip, make sure that all connected system components are out of service.



Note

- Link screen only to terminal S, ensure electrical continuity and connect it once to the central earthing point (CEP).
- The loop resistance must be below 10 Ω .
- The rated voltage is indicated on the name plate.
- When switching off inductive loads, voltage spikes are produced that may impair the operation of control and measuring systems. Provide connected contactors with RC combinations, e. g. 0.1 $\mu\text{F}/100 \Omega$.
- Even in correctly wired systems high frequency interference caused by the installation can lead to system outages and malfunction alarms. For more information please refer to the fault-finding list in the section **Malfunctions Troubleshooting**.

Tools

- Screwdriver for slotted screws, size 2.5, completely insulated according to VDE 0680

Basic Settings

Bus cable

All devices (level, conductivity) are interconnected via CAN bus. The CANopen protocol is used for the data exchange between the equipment groups. All devices have an electronic address – the node ID. The four-core bus cable serves as power supply and data highway for high-speed data exchange.

The CAN address (node ID) can be set between **1 – 123**.

The URB 1 has already been configured at our works for operation with other GESTRA components and can be used straight away without having to set the node ID.

If several identical systems are to communicate in a CAN bus network, set a different node ID for each system (e. g. limiter, controller, etc).

If the length of the CAN bus cable exceeds 125 m change the settings of the code switch 7.

For more information on switch positions see **Basic Settings Switch positions**.

Basic Settings – continued –

Node ID

Water level limiter

NRS 1-40	NRG 16-40 (1)	NRG 16-40 (2)	Reserved	Reserved	
X	X + 1	X + 2	X + 3	X + 4	
1	2	3			Factory setting

Safety system for steam boilers with superheater

NRS 1-40.1	NRG 16-40 (1)	NRG 16-40 (2)	TRV 5-40	Limiter 4	
X	X + 1	X + 2	X + 3	X + 4	
1	2	3	4		Factory setting

Safety system (e. g. hot-water generating units)

NRS 1-40.1	NRG 16-40 (1)	NRG 16-40 (2)	Limiter 3	Limiter 4	
X	X + 1	X + 2	X + 3	X + 4	
1	2				Factory setting

Safety system (e. g. hot-water generating units)

NRS 1-40.2*)	TRV 5-40 (1)*	TRV 5-40 (2)*	Limiter 3	Limiter 4	
X	X + 1	X + 2	X + 3	X + 4	
6	7	8	9	10	Factory setting
	TRS 5-40 (1)*	TRS 5-40 (2)*			
	X + 1 + 90	X + 2 + 90			
	97	98			

High level alarm

NRS 1-41	NRG 16-41	Reserved	Reserved	Reserved	
X	X + 1	X + 2	X + 3	X + 4	
6	7	8	9	10	Factory setting

Further components

SRL 40					
X=(sensor: level limiter // hi alarm) + 2					Factory setting
ORT 6					
98					Factory setting

On-off level control

Reserved	NRS 1-42	NRG 16-42			
X - 1	X	X + 1			
19	20	21			Factory setting

Modulating level control

URZ 40*)	NRS 2-40	NRR 2-40	NRG 26-40	Reserved	
X - 2	X - 1	X	X + 1	X + 2	
38	39	40	41	42	Factory setting

Automatic continous blowdown control

EF 1-40*)	Reserved	LRR 1-40	LRG 1-4...	Reserved	
X - 2	X - 1	X	X + 1	X + 2	
48	49	50	51	52	Factory setting

Control unit

URB 1, URB 2					
60					Factory setting

*) Only possible in conjunction with the user-friendly operating unit URB 2!

Basic Settings – continued –

Factory setting

The display unit features the following factory set default values:

- Baud rate: **250 kb/s**
- Node ID: **060** Note: This node ID should only be changed if necessary, max. node ID: 123.

Establishing / changing node ID

If several identical systems are to communicate in a CAN bus network, allocate a different node ID for each system (e. g. limiter, controller, etc). In most cases it is sufficient to commission the equipment with the default factory settings.

The code switch **7** is on the back of the equipment.



Attention

- We recommend that you commission the CAN bus devices with the default factory setting.
- Do **not** use a node ID for more than one piece of equipment in the CAN bus system.

Code switch settings

S1	S2	S3	Baud rate	Cable length
OFF	<i>ON</i>	OFF	250 kBit/s	125 m
<i>ON</i>	<i>ON</i>	OFF	125 kBit/s	250 m
OFF	ON	<i>ON</i>	100 kBit/s	335 m
<i>ON</i>	ON	<i>ON</i>	50 kBit/s	500 m
OFF	<i>ON</i>	<i>ON</i>	20 kBit/s	1,000 m
<i>ON</i>	<i>ON</i>	<i>ON</i>	10 kBit/s	1,000 m

Fig. 8 (Factory setting 250 kBit/s)

Commissioning Procedure

Applying mains voltage

After applying the mains voltage the following information appears on the equipment.

- Equipment version
- Software version
- Operating status:
 - Operational = ready for operation
 - Not Operational = malfunction / new start-up

If the system does not detect a malfunction after the mains voltage has been switched on, the start-up window will appear after several seconds.



Adjusting display contrast

To ensure optimum readability we recommend that you adjust the contrast of the LCD display to the ambient light.

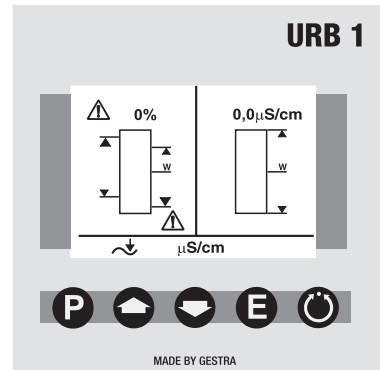

Press button **P** for 3 sec.

The address parameterisation mode of the URB 1 is shown.

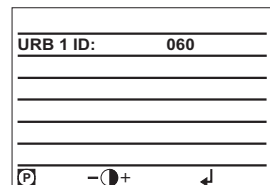

Commissioning – continued –

Adjusting display contrast – continued –

Press button  several times to decrease the contrast.

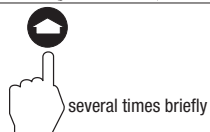
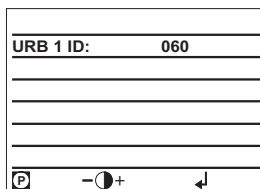

Press button  several times to increase the contrast.

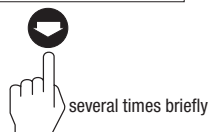
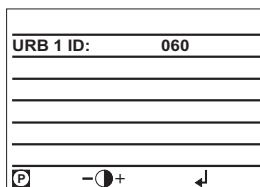

Press button  briefly.
The start window is shown now.

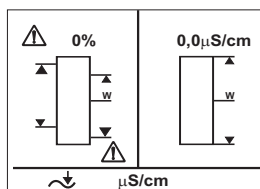

Changing factory set node ID of URB 1, adjusting / changing node ID of URB 1

The default factory set node ID of the URB 1 is “060”. Node IDs **below** “060” are reserved for other GESTRA bus equipment. If additional operating terminals type URB 1 are used in a CAN bus system, you have to set their node IDs to values **above** “060”. Make sure that you do not use the same node IDs for different bus devices.

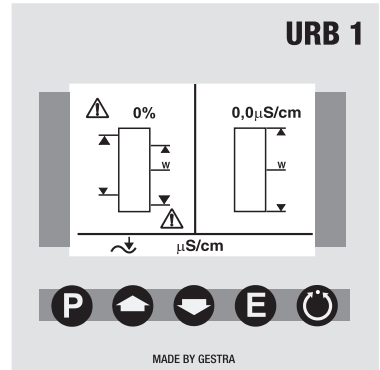

Press button **P** for 3 sec.

The address parameterisation mode of the URB 1 is shown.

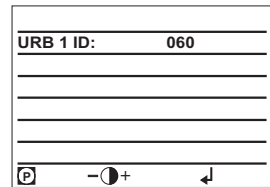

Press button **P** briefly to activate the line selection mode.

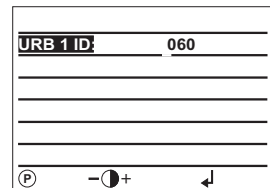

Changing factory set node ID of URB 1, adjusting / changing node ID of URB 1 - continued -

Press button **P** briefly to activate the line editing mode.

Use button  or  to increase or decrease the first digit.

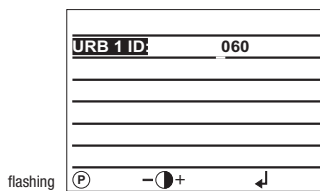

Press button **E** twice briefly to move the cursor two steps further.

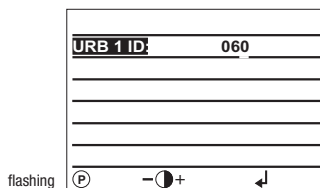

Press button  once briefly to select the digit "1".

In our example the node ID was set to "061".

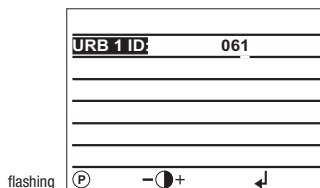

Commissioning – continued –

Changing factory set node ID of URB 1, adjusting / changing node ID of URB 1 – continued –

Press button **E** briefly.

The system will re-start.

The start window appears after approx.
10 seconds.

In our example the node ID was set to “061”.

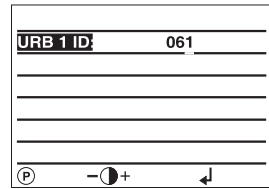

Possibilities to display bus devices

The URB 1 can display only **one** level monitoring device, **one** low-level alarm, **one** high-level alarm and only **one** conductivity monitoring device per vessel (e.g. steam boiler or feedwater deaerator).

If the monitoring systems of more than one vessel are to be displayed, provide **one URB 1 per vessel**.

Setting / changing node IDs of bus-based equipment

The default node ID setting of all bus devices that can be displayed is “OFF”. This setting acts as a wild card for all bus devices which are not displayed with the URB 1.

For each bus device that shall be displayed by the URB 1 a node ID has to be established manually.

We recommend to accept the factory set node IDs of GESTRA bus devices.

For the relevant node ID settings please refer to the corresponding installation manual of the device in question.



Press button **P** briefly to view the address list and activate the parameterisation mode.

NRS 1-40 ID:	OFF
NRS 1-41 ID:	OFF
NRS 1-42 ID:	OFF
NRS 2-40 ID:	OFF
NRR 2-40 ID:	OFF
LRR 1-40 ID:	OFF



Press button **P** briefly to activate the line selection mode.

	NRR 2-40		NRS 2-40	
1 : 030	000	030	000	
2 : 000	000	010	000	
3 : 000	000	010	000	
4 : 030	030	030	000	



Commissioning – continued –

Setting / changing node IDs of bus-based equipment – continued –

Press button **P** briefly to activate the line editing mode.

Use button **↩** or **↪** to increase or decrease the first digit.

flashing **P** ↑ ↓

NRS 1-40 ID:	OFF
NRS 1-41 ID:	OFF
NRS 1-42 ID:	OFF
NRS 2-40 ID:	OFF
NRR 2-40 ID:	OFF
LRR 1-40 ID:	OFF



Press button **↩** once briefly to select the digit “0”.

flashing **P** ↑ ↓

NRS 1-40 ID:	028
NRS 1-41 ID:	OFF
NRS 1-42 ID:	OFF
NRS 2-40 ID:	OFF
NRR 2-40 ID:	OFF
LRR 1-40 ID:	OFF



Press button **E** briefly to move the cursor one step further.

flashing **P** ↑ ↓

NRS 1-40 ID:	028
NRS 1-41 ID:	OFF
NRS 1-42 ID:	OFF
NRS 2-40 ID:	OFF
NRR 2-40 ID:	OFF
LRR 1-40 ID:	OFF



Press button **↩** twice briefly to select the digit “0”.

flashing **P** ↑ ↓

NRS 1-40 ID:	008
NRS 1-41 ID:	OFF
NRS 1-42 ID:	OFF
NRS 2-40 ID:	OFF
NRR 2-40 ID:	OFF
LRR 1-40 ID:	OFF

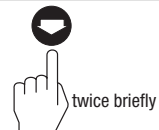



Setting / changing node IDs of bus-based equipment – continued –

Press button **E** briefly to move the cursor one step further.

flashing 



NRS 1-40 ID:	008
NRS 1-41 ID:	OFF
NRS 1-42 ID:	OFF
NRS 2-40 ID:	OFF
NRR 2-40 ID:	OFF
LRR 1-40 ID:	OFF

 **E**
 briefly

Press button  7 times briefly to select the digit "1".



flashing 

NRS 1-40 ID:	001
NRS 1-41 ID:	OFF
NRS 1-42 ID:	OFF
NRS 2-40 ID:	OFF
NRR 2-40 ID:	OFF
LRR 1-40 ID:	OFF

 
 7 times briefly

Press button **E** briefly to activate the line selection mode.





NRS 1-40 ID:	001
NRS 1-41 ID:	OFF
NRS 1-42 ID:	OFF
NRS 2-40 ID:	OFF
NRR 2-40 ID:	OFF
LRR 1-40 ID:	OFF

  **E**
 briefly

Press button  once briefly to move to the next line.

The node ID of the NRS 1-41 can now be adjusted.

NRS 1-40 ID:	001
NRS 1-41 ID:	OFF
NRS 1-42 ID:	OFF
NRS 2-40 ID:	OFF
NRR 2-40 ID:	OFF
LRR 1-40 ID:	OFF

  
 once briefly

Commissioning – continued –

Setting / changing node IDs of bus-based equipment – continued –

Press button **E** briefly to activate the parameterisation mode.

In our example the node IDs of all bus devices have already been adjusted.

If the NRS 1-42 is to be displayed, set the node IDs of the NRS 2-40 and NRR 2-40 to “OFF”.

NRS 1-40 ID:	001
NRS 1-41 ID:	006
NRS 1-42 ID:	OFF
NRS 2-40 ID:	039
NRR 2-40 ID:	040
LRR 1-40 ID:	050



Press button **E** briefly to return to the start window.

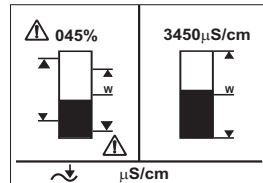

Visual display / parameterisation of bus-based equipment

The split-screen start window shows which GESTRA bus devices can be indicated:

- High level limiter NRS 1-41
- Low level limiter NRS 1-40
- Level switch NRS 2-40
- Level controller NRR 2-40
- Conductivity controller LRR 1-40

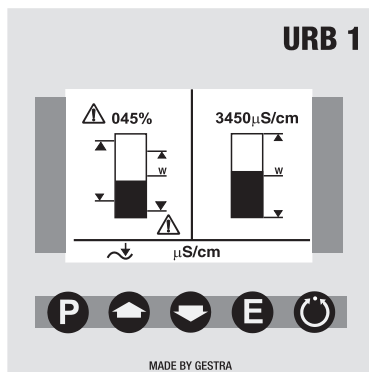

Press button briefly to enter the display window of the level controller NRR 2-40.

- 1 Actual level (graphical representation)
- 2 Actual level (percentage)
- 3 Setpoint deviation
- 4 Proportional band Xp
- 5 Switchpoints NRR 2-40
- 6 Valve position

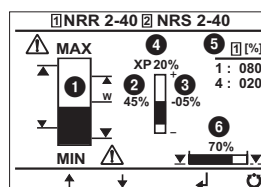

Press button briefly to enter the display window of the level switch NRS 2-40.

- 1 Actual level (graphical representation)
- 2 Actual level (percentage)
- 3 Control unit 2 highlighted
- 4 Switchpoints for control unit 2
- 5 Low-level alarm (flashes in the event of a LW alarm)
- 6 High-level alarm (flashes in the event of a HW alarm)

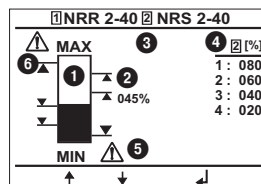

LW = low water (limiter NRS 1-40)
HW = high water (limiter NRS 1-41)

Visual display / parameterisation of bus-based equipment – continued –

Press button  briefly to enter the parameterisation mode for the following settings:

- 0 % - 100 % calibration NRG 26-40
- Switchpoints NRR 2-40
- Proportional band NRR 2-40
- Switchpoints NRS 2-40

1 NRR 2-40		2 NRS 2-40	
0% :	*	1 [%]	2 [%]
100% :	100	1 : 080	080
		2 : 060	060
		3 : 040	040
		4 : 020	020



Press button  briefly to enter the parameterisation mode for the following settings:

- Relay energising times
- Relay de-energising times

1 NRR 2-40		2 NRS 2-40	
1 :	030	000	030
2 :	000	010	000
3 :	000	010	000
4 :	030	030	000



Press button  briefly to enter the error messages window.

For more information see section **Malfunctions, Troubleshooting, Fault Finding List** on pages 79 and 80.

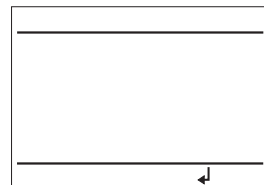

Press button  briefly to return to the start window.

- ① Actual conductivity value
- ② Actual conductivity (graphical representation)

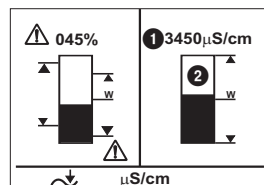

Visual display / parameterisation of bus-based equipment – continued –

Press button  briefly to enter the display window of the conductivity controller LRR 1-40.

- ❶ Actual conductivity value
- ❷ Conductivity setpoint
- ❸ Max. conductivity value
- ❹ 24-h purging pulse for continuous blowdown valve
- ❺ Operating position of the continuous blowdown valve
- ❻ Valve position of the continuous blowdown valve

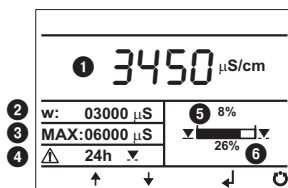

Press button  briefly to enter the parameterisation mode for the following settings:

- $\mu\text{S/cm}$ or ppm
- Measuring range
- Max. conductivity value
- Setpoint
- Min. conductivity value

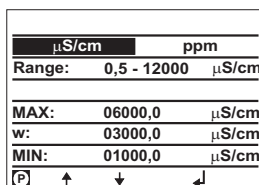

Press button  briefly to enter the parameterisation mode for the following settings:

- Proportional range Xp
- Controller hysteresis
- 24-h purging pulse for continuous blowdown valve
- Operating position of continuous blowdown valve
- Relay contact 4:
MIN limit / automatic intermittent boiler blowdown

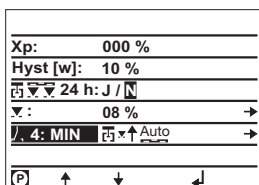

Press button  briefly to enter the parameterisation mode for the following settings:

- Linear temperature compensation **LIN**
- Automatic temperature compensation **AUTO**
- Standard curve temperature compensation **NORM**
- Temperature compensation disabled **OFF**

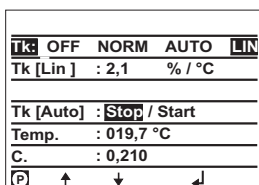

Visual display / parameterisation of bus-based equipment – continued –

Press button  briefly to enter the error messages window.

For more information see section **Malfunctions, Troubleshooting, Fault Finding List** on pages 79 and 80.



Press button  briefly to return to the start window.

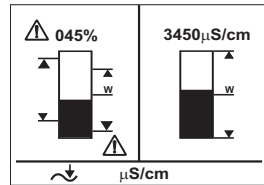

Visual display / parameterisation of bus-based equipment – continued –

The split-screen start window shows which GESTRA bus devices can be indicated:

- Level switch NRS 1-42

This window appears if – as shown in our example – only the NRS 1-42 is displayed.

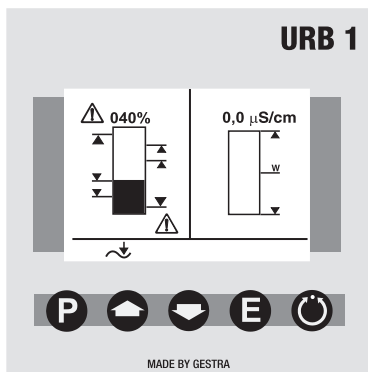

Press button briefly to enter the display window of the level controller NRS 1-42.

- 1 High level switchpoint (MAX)
- 2 Switchpoints
- 3 Low level switchpoint (MIN)

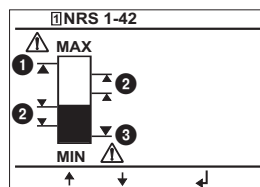

Press button briefly to enter the parameterisation mode for the following settings:

- Minimum conductivity of the liquid 0.5 $\mu\text{S}/\text{cm}$
- Minimum conductivity of the liquid 10 $\mu\text{S}/\text{cm}$

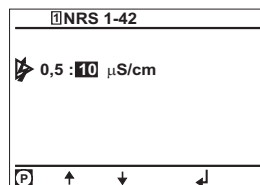

Visual display / parameterisation of bus-based equipment – continued –

Press button  briefly to enter the parameterisation mode for the following settings:

- Relay energising times
- Relay de-energising times

NRS 1-42		
1	2	3
1 : 030	031	
2 : 010	011	
3 : 020	021	
4 : 040	041	



Press button  briefly to enter the error messages window.

For more information see section **Malfunctions, Troubleshooting, Fault Finding List** on pages 79 and 80.

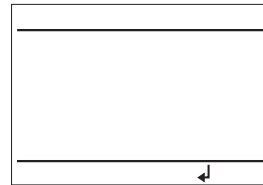

Press button  briefly to return to the start window.

In this example only the bus device NRS 1-42 is displayed.

If the node IDs of the bus devices NRS 2-40 and NRR 2-40 have been established such that the equipment can be displayed on the URB 1, the indication of these devices will take priority over the NRS 1-42 and the display window of the NRS 1-42 will be blanked.

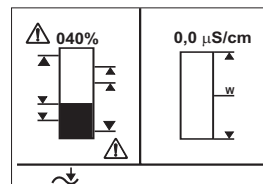

0% to 100% calibration for capacitance level monitoring

The split-screen start window shows which GESTRA bus devices can be indicated:

- High level limiter NRS 1-41
- Low level limiter NRS 1-40
- Level switch NRS 2-40
- Level controller NRR 2-40
- Conductivity controller LRR 1-40

Before commissioning the installation establish the measuring range of the capacitance level electrode NRG 26-40 by calibrating the 0% and 100% settings.

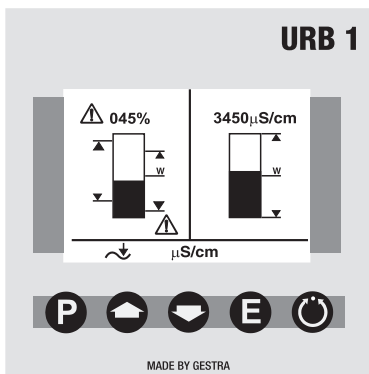

Press button **P** 3 times briefly to enter the window for calibrating the 0% and 100% settings.

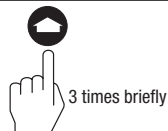
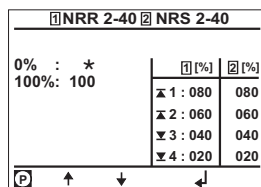

Press button **P** 2 times briefly to activate the line editing mode.

Lower liquid level in the vessel to 0%.

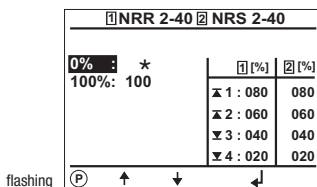

Commissioning – continued –

0 % to 100 % calibration for capacitance level monitoring – continued –

Press button **E** briefly to save the 0 % level setting.

NRR 2-40		NRS 2-40	
0% :	*	[1] [%]	[2] [%]
100% :	100	Δ 1 : 080	080
		Δ 2 : 060	060
		Δ 3 : 040	040
		Δ 4 : 020	020



Press button **◀** once briefly.

NRR 2-40		NRS 2-40	
0% :	*	[1] [%]	[2] [%]
100% :	100	Δ 1 : 080	080
		Δ 2 : 060	060
		Δ 3 : 040	040
		Δ 4 : 020	020



Press button **P** once briefly to activate the line editing mode.

Raise liquid level in the vessel to 100 %.

If, for practical reasons, it is not possible to raise the water level to 100 % please proceed as follows!

flashing

NRR 2-40		NRS 2-40	
0% :	*	[1] [%]	[2] [%]
100% :	100	Δ 1 : 080	080
		Δ 2 : 060	060
		Δ 3 : 040	040
		Δ 4 : 020	020



0% to 100% calibration for capacitance level monitoring – continued –

Press button  5 times briefly.

Pressing the  button in program mode will decrement the calibration level in steps of 10 to a minimum of 50%.

In our example the calibration level is 50%.

This calibration method saves time and prevents the loss of feedwater.

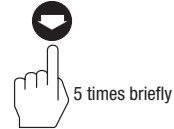
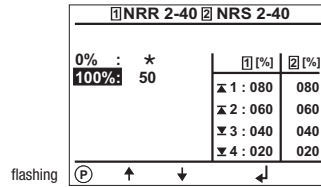

Wait for 30 seconds!

Press button  twice briefly to save the 100% level setting and return to the start window.

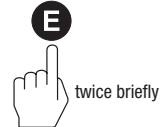
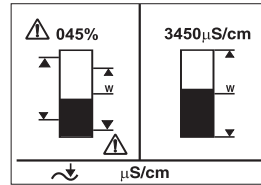



Calibrating the feedback potentiometer of an external control valve

The split-screen start window shows which GESTRA bus devices can be indicated:

- High level limiter NRS 1-41
- Low level limiter NRS 1-40
- Level switch NRS 2-40
- Level controller NRR 2-40
- Conductivity controller LRR 1-40

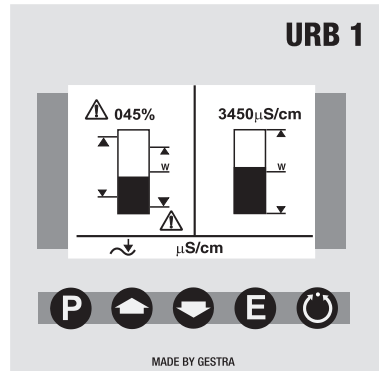
Before commissioning the installation calibrate the 0 % (CLOSED) and 100 % (OPEN) range of the feedback potentiometer of an external control valve.



Press button  briefly to enter the display window of the level controller NRR 2-40.

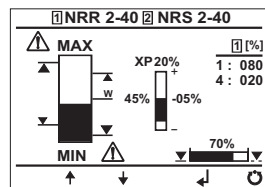

Press button  briefly to activate the manual mode.

Pressing button  or  in this mode enables the manual opening or closing of an external control valve.

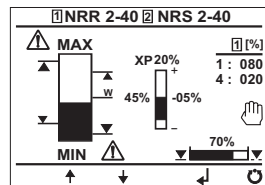

Calibrating the feedback potentiometer of an external control valve – continued –

Press button **P** 3 times briefly to activate the line editing mode for calibrating the signal of the feedback potentiometer.

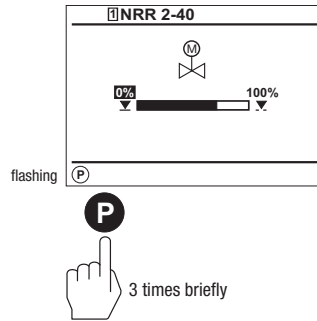

Press and hold down button **▼** until the control valve is closed.

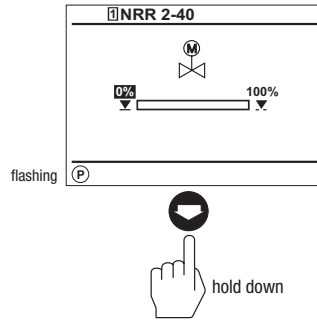

Press button **E** once briefly to save the current resistance value of the feedback potentiometer as 0% setting (valve CLOSED).

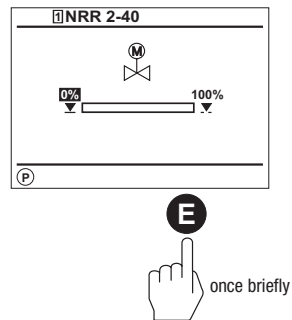

Commissioning – continued –

Calibrating the feedback potentiometer of an external control valve – continued –

Press button  briefly to select the calibration of the 100 % setting.

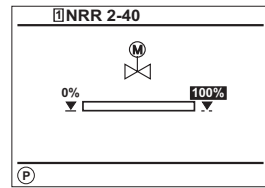

Press button  once briefly to activate the line editing mode for calibrating the signal of the feedback potentiometer.

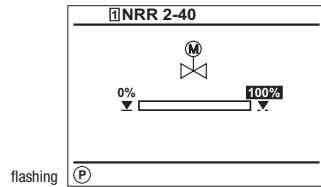

Press and hold down button  until the control valve is open.

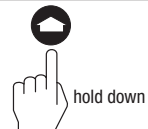
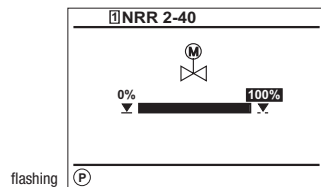

Calibrating the feedback potentiometer of an external control valve – continued –

Press button **E** 3 times briefly to save the current resistance value of the feedback potentiometer as 100 % setting (valve OPEN).

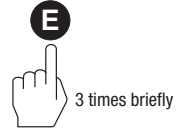
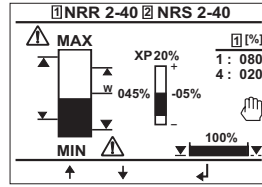

Press button **⏻** briefly to activate the manual mode.

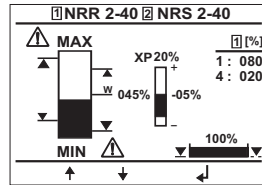

Press button **E** once briefly to return to the start window.

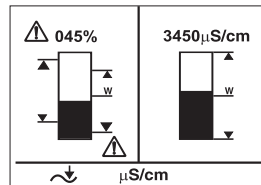

Establishing switchpoints and proportional coefficient Xp

The split-screen start window shows which GESTRA bus devices can be indicated:

- High level limiter NRS 1-41
- Low level limiter NRS 1-40
- Level switch NRS 2-40
- Level controller NRR 2-40
- Conductivity controller LRR 1-40

Before commissioning the installation establish the proportional band and the MAX and MIN switchpoints for the level controller NRR 2-40.

For level switch NRS 2-40 you can establish four switchpoints.

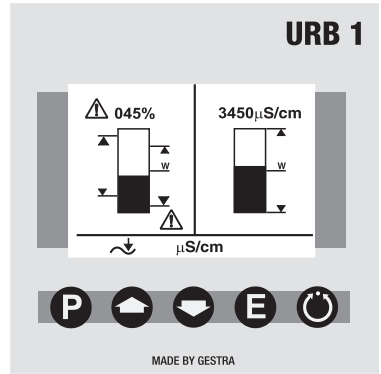

Press button  3 times briefly to enter the window where you can establish the switchpoints and the Xp value.

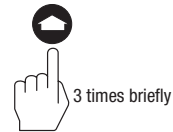
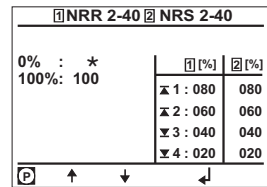

Press button  once briefly to activate the line selection mode.

Use buttons  and  to scroll back and forth through the lines.

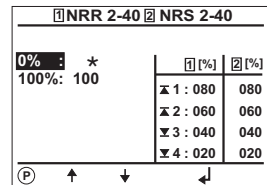

Establishing switchpoints and proportional coefficient Xp – continued –

Press button **◀** twice briefly to select switchpoint 1 (MAX switchpoint) of the NRR 2-40.

NRR 2-40		NRS 2-40	
0% : *		[1] [%]	[2] [%]
100%: 100		▲ 1: 080	080
		▲ 2: 060	060
		▼ 3: 040	040
		▼ 4: 020	020



Press button **P** once briefly to activate the line editing mode.

NRR 2-40		NRS 2-40	
0% : *		[1] [%]	[2] [%]
100%: 100		▲ 1: 080	080
		▲ 2: 060	060
		▼ 3: 040	040
		▼ 4: 020	020

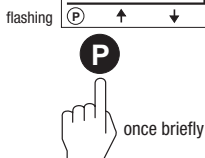

Press button **E** once briefly to move to the next digit in the same line by pressing button **E**.

NRR 2-40		NRS 2-40	
0% : *		[1] [%]	[2] [%]
100%: 100		▲ 1: 080	080
		▲ 2: 060	060
		▼ 3: 040	040
		▼ 4: 020	020

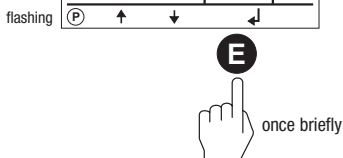

Establishing switchpoints and proportional coefficient Xp – continued –

Press button  once briefly.

In our example switchpoint 1 (MAX switchpoint) shall be established at 70 %.

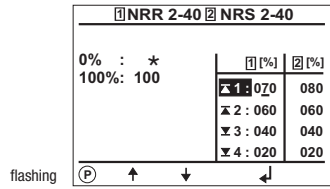

Press button  once briefly.

The last digit in the line is selected (underlined) and remains “0” for our example MAX switchpoint 70 %.

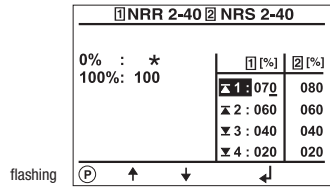

Press button  once briefly to deactivate the line editing mode and press button  to go to the next line.

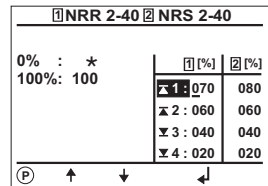

Establishing switchpoints and proportional coefficient Xp – continued –

Press button  once briefly.

Switchpoint 2 marks the upper limit of the proportional band for the level controller NRR 2-40.

The difference between switchpoint 2 and switchpoint 3 gives the magnitude of the proportional range Xp. The example setting corresponds to a proportional band of (060 – 040) 20 %.

The proportional band **must** be greater than “0”!

NRR 2-40		NRS 2-40	
0% : *		[1] [%]	[2] [%]
100%: 100		▲ 1 : 070	080
		▲ 2 : 060	060
		▼ 3 : 040	040
		▼ 4 : 020	020



Press button  once briefly.

Switchpoint 3 marks the lower limit of the proportional band for the level controller NRR 2-40.

The proportional coefficient and the MIN switchpoint of the NRR 2-40 as well as the switchpoints of the NRS 2-40 can be adjusted as described above.

NRR 2-40		NRS 2-40	
0% : *		[1] [%]	[2] [%]
100%: 100		▲ 1 : 070	080
		▲ 2 : 060	060
		▼ 3 : 040	040
		▼ 4 : 020	020



Press button  twice briefly to return to the start window.

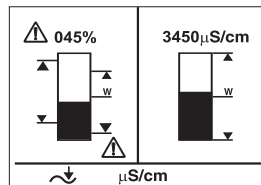

Adjusting sensitivity range

The split-screen start window shows which GESTRA bus devices can be indicated:

- High level limiter NRS 1-41
- Low level limiter NRS 1-40
- Level switch NRS 1-42
- Conductivity controller LRR 1-40

Before commissioning the installation adjust the response sensitivity of the NRS 1-42.

The response sensitivity of the high-level and low-level limiters are factory set and cannot be changed.

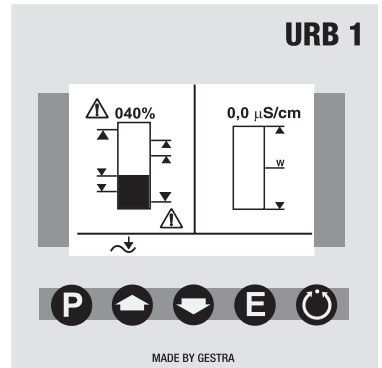

Press button  twice briefly to select either of the following two response sensitivities:

- 0.5 μS/cm
- 10 μS/cm

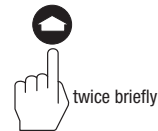
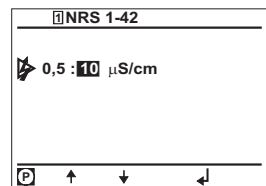

Press button  twice briefly to activate the line editing mode.

Use buttons  and  to toggle between the two settings.

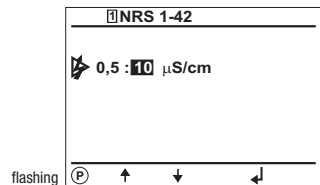

Adjusting sensitivity range – continued –

Press button  briefly.

In our example the response sensitivity **0.5 $\mu\text{S}/\text{cm}$** has been selected.

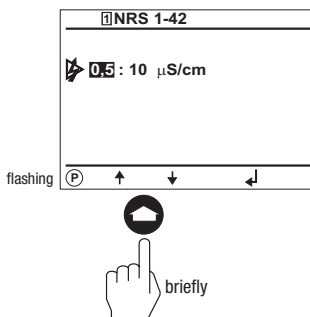

Press button  3 times briefly to return to the start window.

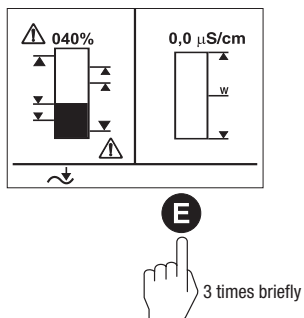

Setting relay energizing times

The split-screen start window shows which GESTRA bus devices can be indicated:

- High level limiter NRS 1-41
- Low level limiter NRS 1-40
- Level switch NRS 2-40
- Level controller NRR 2-40
- Conductivity controller LRR 1-40

When commissioning the installation set the relay energizing times for the individual switchpoints.

Note that the relay energizing times of the low-level and high-level limiters are factory set and **cannot** be changed with the URB 1.

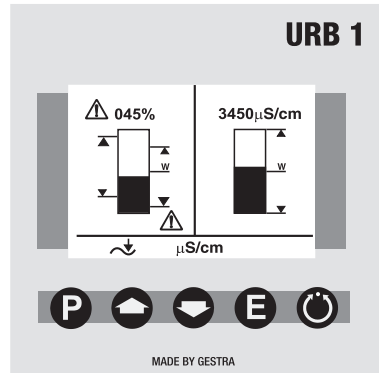

Press button 4 times briefly to enter the window for setting the relay energizing times of the switchpoints.

The symbol stands for “energizing relay”.

The symbol stands for “de-energizing relay”.

The digit - for instance “001” – corresponds to a delay time of 100 mS. The value “030” corresponds to 3 sec. and max. value “255” corresponds to 25.5 sec.

1 NRR 2-40 2 NRS 2-40					
1			2		
1 :	030	000	030	000	
2 :	000	000	010	000	
3 :	000	000	010	000	
4 :	030	030	030	000	

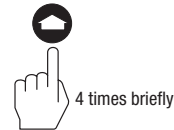

Press button once briefly to activate the line selection mode.

Use buttons and to scroll back and forth through the lines.

1 NRR 2-40 2 NRS 2-40					
1			2		
1 :	030	000	030	000	
2 :	000	000	010	000	
3 :	000	000	010	000	
4 :	030	030	030	000	



Commissioning – continued –

Setting relay energizing times – continued –

Press button **P** once briefly to activate the line editing mode.

1 NRR 2-40		2 NRS 2-40	
1	2	3	4
1: 030	000	030	000
2: 000	000	010	000
3: 000	000	010	000
4: 030	030	030	000

flashing (P) ↑ ↓ ↵



Press button **E** once briefly to move to the next digit in the same line by pressing button **E**.

1 NRR 2-40		2 NRS 2-40	
1	2	3	4
1: 030	000	030	000
2: 000	000	010	000
3: 000	000	010	000
4: 030	030	030	000

flashing (P) ↑ ↓ ↵



Press button **↵** once briefly to select the digit “2”.

1 NRR 2-40		2 NRS 2-40	
1	2	3	4
1: 020	000	030	000
2: 000	000	010	000
3: 000	000	010	000
4: 030	030	030	000

flashing (P) ↑ ↓ ↵

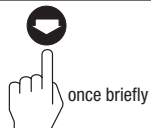

Commissioning – continued –

Setting relay energizing times - continued -

Press button **E** twice briefly to de-activate the line editing mode.

In our example the relay energizing time for the MAX switchpoint of the NRR 2-40 is **2 sec.**

1 NRR 2-40		2 NRS 2-40	
1	↵	↵	2
1 : 020	000	030	000
2 : 000	000	010	000
3 : 000	000	010	000
4 : 030	030	030	000



Press button **↵** once briefly.

In the second column you can adjust the relay de-energizing delay.

Press button **P** / **E** to activate / deactivate the line editing mode.

1 NRR 2-40		2 NRS 2-40	
1	↵	2	↵
1 : 020	000	030	000
2 : 000	000	010	000
3 : 000	000	010	000
4 : 030	030	030	000



Press button **↵** once briefly.

Switchpoint 2 and switchpoint 3 of the NRR 2-40 mark the upper and lower limit of the proportional band. The relay energizing and de-energizing times **cannot** be adjusted and have the number “000”.

The relay energizing times of all other switchpoints can be adjusted as described above.

1 NRR 2-40		2 NRS 2-40	
1	↵	2	↵
1 : 020	000	030	000
2 : 000	000	010	000
3 : 000	000	010	000
4 : 030	030	030	000



Press button **E** twice briefly to return to the start window.

1 NRR 2-40		2 NRS 2-40	
1	↵	2	↵
1 : 020	000	030	000
2 : 000	000	010	000
3 : 000	000	010	000
4 : 030	030	030	000

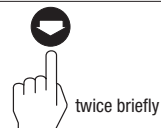

Adjusting conductivity controller

The split-screen start window shows which GESTRA bus devices can be indicated:

- High level limiter NRS 1-41
- Low level limiter NRS 1-40
- Level switch NRS 2-40
- Level controller NRR 2-40
- Conductivity controller LRR 1-40

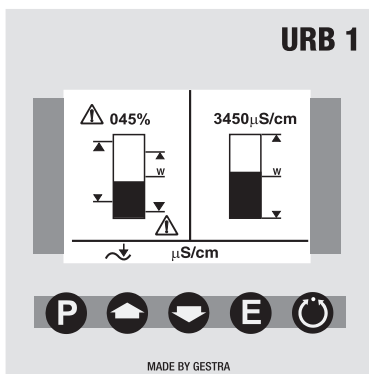

Press button twice briefly to enter the parameterisation mode for the following settings:

- $\mu\text{S/cm}$ or ppm
- Measuring range
- Max. conductivity value
- Setpoint
- Min. conductivity value

$\mu\text{S/cm}$	ppm
Range:	0,5 - 12000 $\mu\text{S/cm}$
MAX:	07000,0 $\mu\text{S/cm}$
w:	05000,0 $\mu\text{S/cm}$
MIN:	01000,0 $\mu\text{S/cm}$

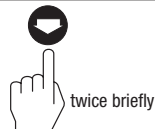

Press button twice briefly to activate the line editing mode.

Use buttons and to scroll back and forth through the lines.

flashing

$\mu\text{S/cm}$	ppm
Range:	0,5 - 12000 $\mu\text{S/cm}$
MAX:	07000,0 $\mu\text{S/cm}$
w:	05000,0 $\mu\text{S/cm}$
MIN:	01000,0 $\mu\text{S/cm}$







Commissioning – continued –

Adjusting conductivity controller – continued –

Press button  once briefly to select the unit [ppm].

	$\mu\text{S/cm}$	ppm
Range:	0,5 - 12000	$\mu\text{S/cm}$
MAX:	07000,0	$\mu\text{S/cm}$
w:	05000,0	$\mu\text{S/cm}$
MIN:	01000,0	$\mu\text{S/cm}$





flashing    

 once briefly

Press button  once briefly to de-activate the line editing mode.

All conductivity readings will now be indicated in [ppm].

	$\mu\text{S/cm}$	ppm
Range:	0,5 - 12000	$\mu\text{S/cm}$
MAX:	07000,0	$\mu\text{S/cm}$
w:	05000,0	$\mu\text{S/cm}$
MIN:	01000,0	$\mu\text{S/cm}$





 once briefly

Press button  once briefly.

In this line you can calibrate the graphical representation (bar chart) of the conductivity value shown in the main window. This setting will also standardize the actual value output (4-20 mA).

First ascertain the conductivity measuring range used in your installation (e. g. **0.5 $\mu\text{S/cm}$ to 20 $\mu\text{S/cm}$**).

	$\mu\text{S/cm}$	ppm
Range:	0,5 - 12000	$\mu\text{S/cm}$
MAX:	07000,0	$\mu\text{S/cm}$
w:	05000,0	$\mu\text{S/cm}$
MIN:	01000,0	$\mu\text{S/cm}$





 once briefly

Press button  once briefly to activate the line editing mode.

You can choose between the following ranges:

- 0.5 to 20 $\mu\text{S/cm}$ ■ 0.5 to 1000 $\mu\text{S/cm}$
- 0.5 to 100 $\mu\text{S/cm}$ ■ 0.5 to 2000 $\mu\text{S/cm}$
- 0.5 to 200 $\mu\text{S/cm}$ ■ 0.5 to 6000 $\mu\text{S/cm}$
- 0.5 to 500 $\mu\text{S/cm}$ ■ 0.5 to 12000 $\mu\text{S/cm}$

	$\mu\text{S/cm}$	ppm
Range:	0,5 - 12000	$\mu\text{S/cm}$
MAX:	07000,0	$\mu\text{S/cm}$
w:	05000,0	$\mu\text{S/cm}$
MIN:	01000,0	$\mu\text{S/cm}$

flashing    

 once briefly

Adjusting conductivity controller – continued –

Press button **◀** 7 times briefly to select the range 0.5 to 20 $\mu\text{S}/\text{cm}$.

flashing **P** ↑ ↓ ↵

$\mu\text{S}/\text{cm}$	ppm
Range: 0,5 - 20	$\mu\text{S}/\text{cm}$
MAX: 07000,0	$\mu\text{S}/\text{cm}$
w: 05000,0	$\mu\text{S}/\text{cm}$
MIN: 01000,0	$\mu\text{S}/\text{cm}$

◀
7 times briefly

Press button **E** once briefly to de-activate the line editing mode.

$\mu\text{S}/\text{cm}$	ppm
Range: 0,5 - 12000	$\mu\text{S}/\text{cm}$
MAX: 07000,0	$\mu\text{S}/\text{cm}$
w: 05000,0	$\mu\text{S}/\text{cm}$
MIN: 01000,0	$\mu\text{S}/\text{cm}$

E
once briefly

Press button **▶** once briefly to enter the line where the conductivity setpoint of the LRR 1-40 can be adjusted.

$\mu\text{S}/\text{cm}$	ppm
Range: 0,5 - 12000	$\mu\text{S}/\text{cm}$
MAX: 07000,0	$\mu\text{S}/\text{cm}$
w: 05000,0	$\mu\text{S}/\text{cm}$
MIN: 01000,0	$\mu\text{S}/\text{cm}$

▶
once briefly

Press button **P** once briefly to activate the line editing mode.

flashing **P** ↑ ↓ ↵

$\mu\text{S}/\text{cm}$	ppm
Range: 0,5 - 12000	$\mu\text{S}/\text{cm}$
MAX: 07000,0	$\mu\text{S}/\text{cm}$
w: 05000,0	$\mu\text{S}/\text{cm}$
MIN: 01000,0	$\mu\text{S}/\text{cm}$

P
once briefly

Commissioning – continued –

Adjusting conductivity controller – continued –

Press button **E** once briefly to move the cursor one step further.

flashing

$\mu\text{S/cm}$	ppm
Range: 0,5 - 12000	$\mu\text{S/cm}$
MAX: 07000,0	$\mu\text{S/cm}$
<u>W:</u> 05000,0	$\mu\text{S/cm}$
MIN: 01000,0	$\mu\text{S/cm}$

E once briefly

Press button **◀** twice briefly to select the digit “3”.

flashing

$\mu\text{S/cm}$	ppm
Range: 0,5 - 12000	$\mu\text{S/cm}$
MAX: 07000,0	$\mu\text{S/cm}$
<u>W:</u> 03000,0	$\mu\text{S/cm}$
MIN: 01000,0	$\mu\text{S/cm}$

◀ twice briefly

Press button **E** 5 times briefly.
In our example a conductivity setpoint of 3000 $\mu\text{S/cm}$ has been adjusted.

$\mu\text{S/cm}$	ppm
Range: 0,5 - 12000	$\mu\text{S/cm}$
MAX: 07000,0	$\mu\text{S/cm}$
<u>W:</u> 03000,0	$\mu\text{S/cm}$
MIN: 01000,0	$\mu\text{S/cm}$

E 5 times briefly

Press button **◀** once briefly to enter the line where the MIN conductivity value of the LRR 1-40 can be adjusted.

The MIN switchpoint of the LRR 1-40 can be adjusted in the same way as the conductivity setpoint.

$\mu\text{S/cm}$	ppm
Range: 0,5 - 12000	$\mu\text{S/cm}$
MAX: 07000,0	$\mu\text{S/cm}$
w: 03000,0	$\mu\text{S/cm}$
<u>MIN:</u> 01000,0	$\mu\text{S/cm}$

◀ once briefly

Adjusting conductivity controller – continued –

Press button **◀** once briefly to enter the line where the MAX conductivity value of the LRR 1-40 can be adjusted.

The MAX switchpoint of the LRR 1-40 can be adjusted in the same way as the conductivity setpoint.

$\mu\text{S/cm}$	ppm
Range:	0,5 - 12000 $\mu\text{S/cm}$
MAX:	07000,0 $\mu\text{S/cm}$
w:	03000,0 $\mu\text{S/cm}$
MIN:	01000,0 $\mu\text{S/cm}$



Press button **E** once briefly to de-activate the line editing mode.

$\mu\text{S/cm}$	ppm
Range:	0,5 - 12000 $\mu\text{S/cm}$
MAX:	07000,0 $\mu\text{S/cm}$
w:	05000,0 $\mu\text{S/cm}$
MIN:	01000,0 $\mu\text{S/cm}$



Press button **▶** once briefly to enter the parameterisation mode for the following settings:

- Proportional range Xp
- Controller hysteresis
- 24-h purging pulse for continuous blowdown valve
- Operating position of continuous blowdown valve
- Relay contact 4: / automatic intermittent boiler blowdown

Xp:	000 %
Hyst [w]:	10 %
24 h:	0 / N
▼:	08 % →
∩, 4: MIN	Auto →



Press button **P** twice briefly to activate the line editing mode.

In this line you can set the **proportional band Xp**.

Xp = 000: Two position (on-off) control

Xp > 000: Modulating control

→

Xp:	000 %
Hyst [w]:	10 %
24 h:	0 / N
▼:	08 % →
∩, 4: MIN	Auto →

flashing P



Commissioning – continued –

Adjusting conductivity controller – continued –

Press button **E** once briefly to move the cursor one step further.

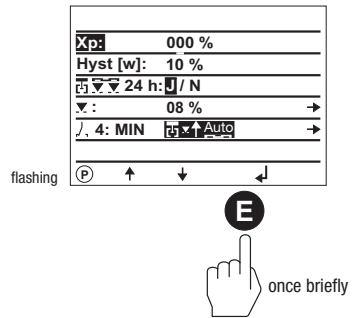

Press button **⬆** twice briefly, to select the digit “2”.

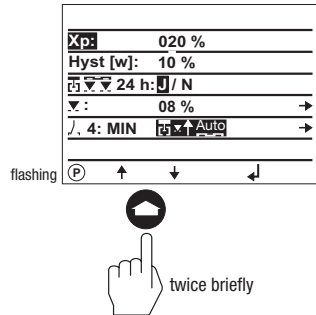

Press button **E** twice briefly.

In our example the proportional range Xp was set to 20 %.

The controller works now as three-position steping controller. As a consequence the hysteresis and the operating position do not have to be adjusted.

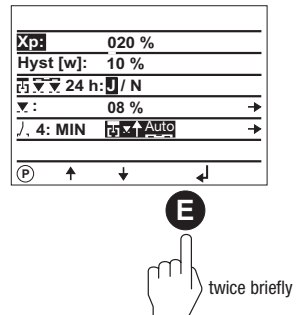

Press button **⬆** once briefly to enter the line where the **control hysteresis** of the LRR 1-40 can be adjusted.

The hysteresis can be adjusted within a range of 0 % to 25 %.

The control hysteresis of the LRR 1-40 can be adjusted in the same way as the proportional band Xp.

If $X_p > 0$ this function is deactivated!

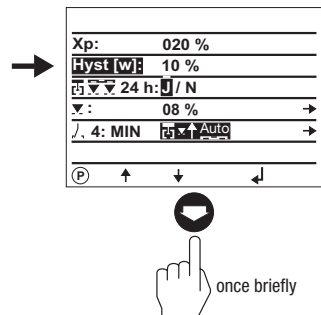

Adjusting conductivity controller – continued –

Press button  once briefly to enter the line where the **24 h purging pulse** for the continuous blowdown valve can be adjusted.

Use buttons  and  to activate or deactivate the 24 h purging pulse .

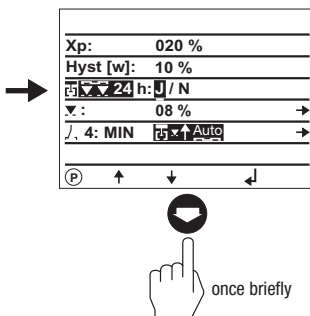

Press button  once briefly to enter the line where the **operating position** of the continuous blowdown valve can be changed.

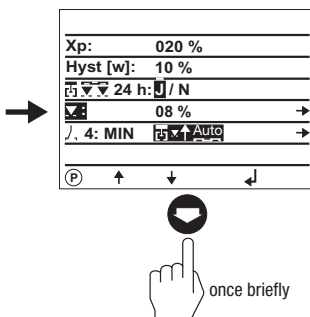

Press button  once briefly to enter the window where the operating position and the feedback potentiometer of the continuous blowdown valve can be adjusted.

If $X_p > 0$ the operating position setting is deactivated.

The window shows also the reference values (in %) as indicated in the scale of the GESTRA continuous blowdown valve BAE 46, BAE 47 (0 = 0 %, 4 = 100 %) and the current position of the continuous blowdown valve in %.

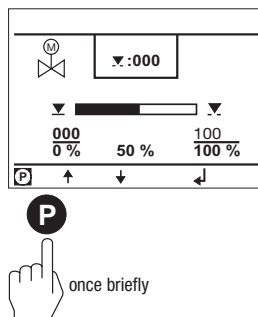

Press button  twice briefly to activate the line editing mode.

Use button  and  to change the values of the digits. Press  to go to the next digit.

The value "008" corresponds to an opening position of 8 %. Max. value: 25 %.

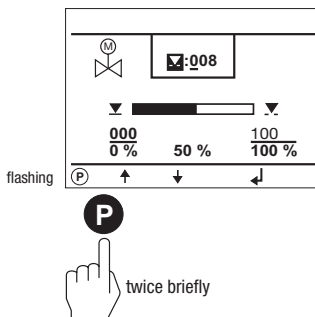

Commissioning – continued –

Adjusting conductivity controller – continued –

Press button **E** once briefly.

The value 008 = 8% operating position is now selected.

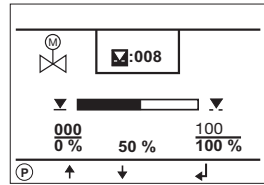

Press button **◀** once briefly to enter the line where the **0% value** of the feedback potentiometer of the continuous blowdown valve can be adjusted.

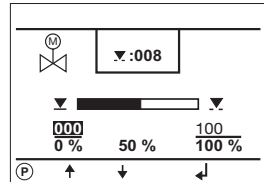

Press button **P** once briefly to activate the line editing mode.

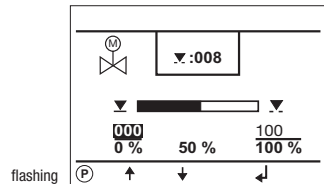

Press and hold down button **◀** until the continuous blowdown valve is closed.

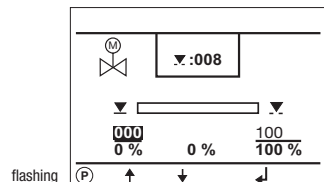

Adjusting conductivity controller – continued –

Press button **E** once briefly to save the current resistance value of the feedback potentiometer as 0 % position (valve CLOSED).

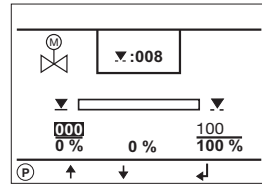

Press button **↵** once briefly to select the 100 % calibration position.

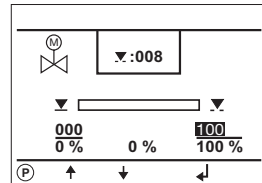

Press button **P** once briefly to activate the line editing mode.

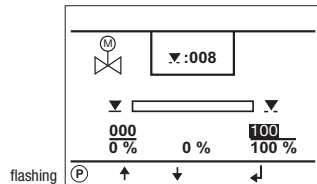

Press and hold down button **⏮** until the continuous blowdown valve is completely open.

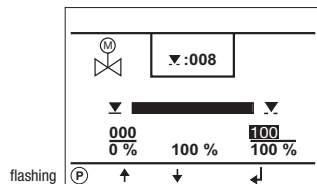

Commissioning – continued –

Adjusting conductivity controller – continued –

Press button **E** once briefly to save the current resistance value of the feedback potentiometer as 100% position (valve OPEN).

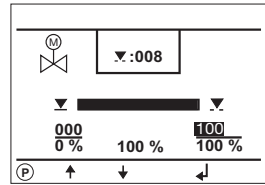

Press button **E** 3 times briefly.

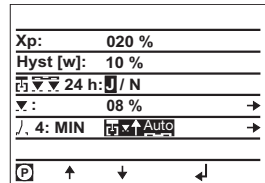

Press button **P** once briefly to activate the line selection mode.

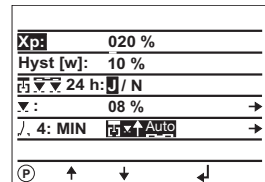

Press button **◀** 4 times briefly.

In this line you can decide whether you want to use relay contact 4 (LRR 1-40) for **MIN alarm** or for **automatic intermittent boiler blowdown**.

The relay contact 4 of the LRR 1-40 is located across terminals "28", "29" and "30".

Please observe the wiring diagram of the LRR 1-40.

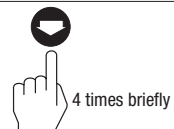
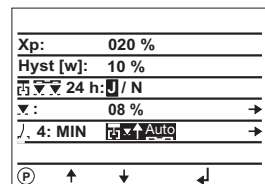

Adjusting conductivity controller – continued –

Press button **P** once briefly to activate the line editing mode.

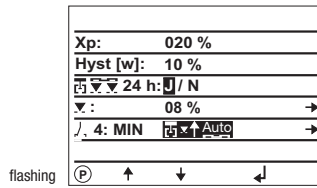

Press button **⬆** once briefly to activate relay contact 4 for establishing for instance a MIN alarm.

The relay contact 4 of the LRR 1-40 is located across terminals “28”, “29” and “30”.

Please observe the wiring diagram of the LRR 1-40.

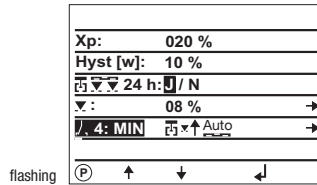

Press button **⬇** once briefly to activate the automatic intermittent blowdown function.

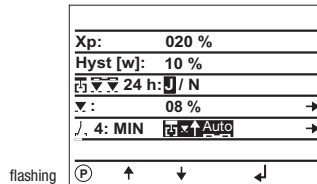

Press button **E** once briefly to enter the parameterisation mode for the following settings:

- Frequency of the intermittent blowdown in hours
- Duration of the intermittent blowdown in seconds

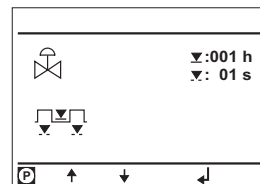

Commissioning – continued –

Adjusting conductivity controller – continued –

Press button **P** once briefly to activate the line selection mode.

The **frequency of intermittent blowdown** can be adjusted in the line editing mode in the same way as the proportional band Xp.

Press button **P** / **E** to activate / deactivate the line editing mode.

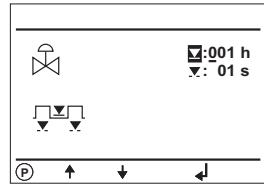

Press button **◀** once briefly.

The **duration of intermittent blowdown** can be adjusted in the line editing mode in the same way as the proportional band Xp.

In our example the blowdown frequency was set to 1 hour and the blowdown duration to 1 second.

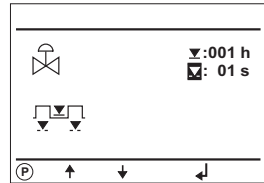

Press button **E** twice briefly to accept and save the configuration.

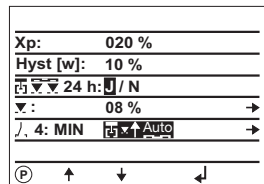

Press button **E** twice briefly to return to the start window.

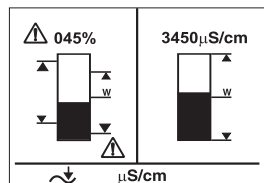

Adjusting linear (LIN) temperature compensation

The split-screen start window shows which GESTRA bus devices can be indicated:

- High level limiter NRS 1-41
- Low level limiter NRS 1-40
- Level switch NRS 2-40
- Level controller NRR 2-40
- Conductivity controller LRR 1-40

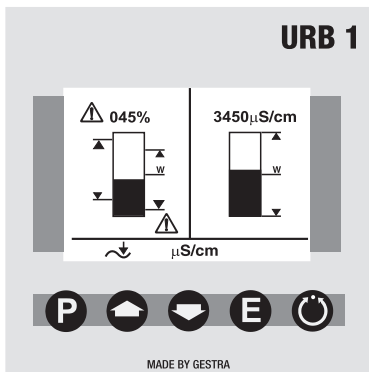

Press button **⏏** 4 times briefly to enter the parameterisation mode for the following settings:

- Linear temperature compensation [%/°C]
- Recording a temperature curve
- Cell constant C of the conductivity electrode

In our example we start from the default factory setting "TK:LIN".

Tk:	OFF	NORM	AUTO	LIN
Tk [Lin]	: 2,1 % / °C			
Tk [Auto]	: Stop / Start			
Temp.	: 019,7 °C			
C.	: 0,210			
	⏏	↑	↓	↩



Press button **P** once briefly to activate the line selection mode.

TK :	OFF	NORM	AUTO	LIN
Tk [Lin]	: 2,1 % / °C			
Tk [Auto]	: Stop / Start			
Temp.	: 019,7 °C			
C.	: 0,210			
	P	↑	↓	↩



Adjusting linear (LIN) temperature compensation – continued –

Press button **◀** once briefly to enter the line where the linear temperature compensation [%/°C] can be adjusted.

The gradient (default setting: 2.1 [% / °C]) is normally used for steam boilers operating with constant pressure. When the boiler is at full working pressure compare the indicated value with the reading of a calibrated conductivity meter – the two values must tally.

Tk:	OFF	NORM	AUTO	LIN
Tk [Lin]	2,1 % / °C			
Tk [Auto]	Stop / Start			
Temp.	: 019,7 °C			
C.	: 0,210			
Ⓟ	↑	↓	↵	



Press button **Ⓟ** once briefly to activate the line editing mode.

If the reading of the calibrated conductivity meter does not tally the value indicated by the URB 1 the compensation gradient has to be changed until the two values agree.

Example: With a gradient of 1.9 % / °C the two readings tally.

flashing

Tk:	OFF	NORM	AUTO	LIN
Tk [Lin]	2,1 % / °C			
Tk [Auto]	Stop / Start			
Temp.	: 019,7 °C			
C.	: 0,210			
Ⓟ	↑	↓	↵	



Press button **▶** once briefly to select the digit “1”.

flashing

Tk:	OFF	NORM	AUTO	LIN
Tk [Lin]	1,1 % / °C			
Tk [Auto]	Stop / Start			
Temp.	: 019,7 °C			
C.	: 0,210			
Ⓟ	↑	↓	↵	



Press button **E** once briefly to move the cursor one step further.

flashing

Tk:	OFF	NORM	AUTO	LIN
Tk [Lin]	1,1 % / °C			
Tk [Auto]	Stop / Start			
Temp.	: 019,7 °C			
C.	: 0,210			
Ⓟ	↑	↓	↵	



Adjusting linear (LIN) temperature compensation – continued –

Press button **◀** twice briefly to select the digit “9”.

flashing

Tk:	OFF	NORM	AUTO	LIN
Tk [Lin]	:	1,9	% / °C	
Tk [Auto]	:	Stop / Start		
Temp.	:	019,7 °C		
C.	:	0,210		
Ⓟ	↑	↓	↵	



Press button **E** once briefly to accept and save the configuration.

In our example a gradient of 1.9 % / °C was adjusted.

Tk:	OFF	NORM	AUTO	LIN
Tk [Lin]	:	1,9	% / °C	
Tk [Auto]	:	Stop / Start		
Temp.	:	019,7 °C		
C.	:	0,210		
Ⓟ	↑	↓	↵	



Press button **E** twice briefly to return to the start window.

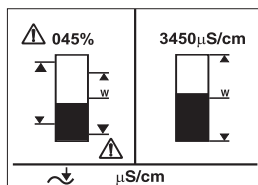

Adjusting standard curve (NORM) temperature compensation

The split-screen start window shows which GESTRA bus devices can be indicated:

- High level limiter NRS 1-41
- Low level limiter NRS 1-40
- Level switch NRS 2-40
- Level controller NRR 2-40
- Conductivity controller LRR 1-40

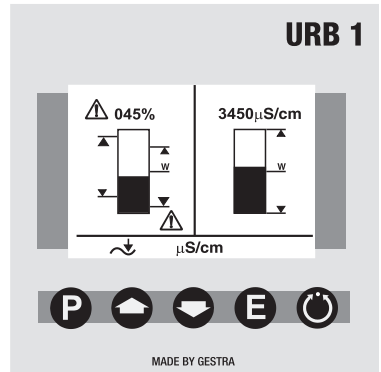

Press button **P** 4 times briefly.

The NORM (standard curve) temperature compensation is suitable for boilers operating with variable pressure, which means that the boiler does not have a fixed working pressure (e. g. low load 10 bar, full load 15 bar).

The standard curves of 11 feedwater conditioning agents with different basic conductivities compensate for thermal influences on measurements within the operating range. In our example we start from the default factory setting “TK:LIN”.

Tk:	OFF	NORM	AUTO	LIN
Tk [Lin]	: 2,1 % / °C			
Tk [Auto]	: Stop / Start			
Temp.	: 019,7 °C			
C.	: 0,210			
P	↑	↓	↵	



4 times briefly

Press button **P** twice briefly to activate the line editing mode.

flashing

Tk :	OFF	NORM	AUTO	LIN
Tk [Lin]	: 2,1 % / °C			
Tk [Auto]	: Stop / Start			
Temp.	: 019,7 °C			
C.	: 0,210			
P	↑	↓	↵	







twice briefly

Adjusting NORM (standard curve) temperature compensation – continued –

Press button  twice briefly to select the function “NORM”.

The function “NORM” allows the retrieval of 9 different standard temperature curves stored in the URB 1. The curves are applicable for various feedwater conditioning agents with different basic conductivities.

Tk:	OFF	NORM	AUTO	LIN
Tk [Lin] :	2,1 % / °C			
Tk [Auto] :	Stop / Start			
Temp. :	019,7 °C			
C. :	0,210			
				





flashing



Press button  once briefly to activate the line selection mode and to enter the parameterisation mode for the following settings:





- NORM (standard curve) temperature compensation [% / °C]
- Recording a temperature curve
- Cell constant C of the conductivity electrode

Our example shows “00” (**factory setting**), which means that **no** standard curve has been selected and activated.

Tk:	OFF	NORM	AUTO	LIN
Tk [Tab] :	00			
Tk [Auto] :	Stop / Start			
Temp. :	019,7 °C			
C. :	0,210			
				



Press button  once briefly to enter the line where you can select a standard curve.





Tk:	OFF	NORM	AUTO	LIN
Tk [Tab] :	00			
Tk [Auto] :	Stop / Start			
Temp. :	019,7 °C			
C. :	0,210			
				



Press button  once briefly to activate the line editing mode.

The first digit (10) is active.

Press button  to move to the second digit (1).

Tk:	OFF	NORM	AUTO	LIN
Tk [Tab] :	00			
Tk [Auto] :	Stop / Start			
Temp. :	019,7 °C			
C. :	0,210			
				

flashing



Adjusting NORM (standard curve) temperature compensation – continued –

No.	Conditioning agent	Basic conductivity at 25 °C
1	Caustic soda	260 [µS/cm]
2	Caustic soda	1080 [µS/cm]
3	Caustic soda	5400 [µS/cm]
4	Caustic soda	11000 [µS/cm]
5	Trisodium phosphate	190 [µS/cm]
6	Trisodium phosphate	1100 [µS/cm]
7	Trisodium phosphate	5900 [µS/cm]
8	Trisodium phosphate	11200 [µS/cm]
9	Sodium sulphite	980 [µS/cm]
10	Dipolique 444®	200 [µS/cm]
11	Levoxin®	195 [µS/cm]

Press button  once briefly to select the digit “1”.

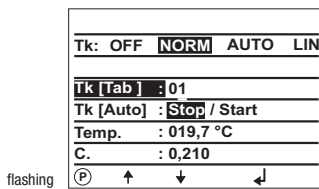

Press button  once briefly to accept and save the configuration and to activate the standard curve “1”.

The temperature values of the standard curve “1” are based on the conditioning agent caustic soda with a basic conductivity of 260 µS/cm at 25 °C.

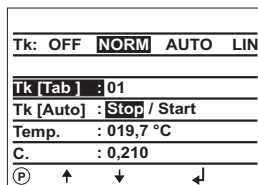





Adjusting NORM (standard curve) temperature compensation – continued –

Press button  once briefly to enter the line where you can start recording the temperature / conductivity curve that is characteristic of your steam boiler.

The system detects the temp./conductivity values from room temperature to operating temperature.



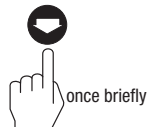

In case of variable pressure operation we recommend that you also record the AUTO curve. If the standard curves are not suitable, you can use the AUTO curve.

Tk:	OFF	NORM	AUTO	LIN
Tk [Tab]	01			
Tk [Auto]	: Stop / Start			
Temp.	: 019,7 °C			
C.	: 0,210			
				



Press button  once briefly to activate the line editing mode.





flashing

Tk:	OFF	NORM	AUTO	LIN
Tk [Tab]	01			
Tk [Auto]	: Stop / Start			
Temp.	: 019,7 °C			
C.	: 0,210			
				



Press button  once briefly to select the function “Start”.

flashing

Tk:	OFF	NORM	AUTO	LIN
Tk [Tab]	01			
Tk [Auto]	: Stop / Star			
Temp.	: 019,7 °C			
C.	: 0,210			
				

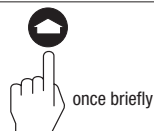

Enabling automatic (AUTO) temperature compensation

The split-screen start window shows which GESTRA bus devices can be indicated:

- High level limiter NRS 1-41
- Low level limiter NRS 1-40
- Level switch NRS 2-40
- Level controller NRR 2-40
- Conductivity controller LRR 1-40

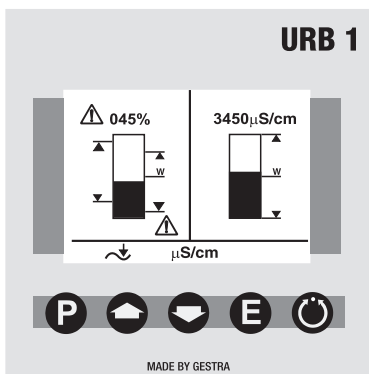





Press button  4 times briefly.

The AUTO curves for temperature compensation are suitable for boilers operating with variable pressure, which means that the boiler does not have a fixed working pressure/temperature (e. g. low load 10 bar, full load 15 bar).

The procedure for recording an AUTO curve is described on pages 69 to 71.

In our example we have started from the setting "TK:NORM".





Tk:	OFF	NORM	AUTO	LIN
Tk [Tab]	: 01			
Tk [Auto]	: Stop / Start			
Temp.	: 0181,7 °C	15		
C.	: 0,210			
				



4 times briefly

Press button  twice briefly to activate the line editing mode.

flashing

Tk:	OFF	NORM	AUTO	LIN
Tk [Tab]	: 01			
Tk [Auto]	: Stop / Start			
Temp.	: 0181,7 °C	15		
C.	: 0,210			
				



twice briefly

Enabling automatic (AUTO) temperature compensation – continued –

Press button **⏏** once briefly to select the function “AUTO”.

Please note:

If no AUTO curve is stored, the URB 1 switches to linear temperature compensation.

The digit to the right in the line “Temp.” indicates that an AUTO curve is stored.

In our example 15 temperatures values are stored in the URB 1

Tk:	OFF	NORM	AUTO	LIN
Tk [Tab] :	01			
Tk [Auto] :	Stop / Start			
Temp. :	0181,7 °C			15
C. :	0,210			
Ⓟ	↑	↓	↙	

flashing



once briefly

Press button **E** twice briefly to accept and save the configuration.

In our example the AUTO curve recorded and saved in the URB 1 has been activated with 15 temp./conductivity values.

The AUTO curve can be overwritten by a newly recorded curve at any time.

The procedure for recording an AUTO curve is described on pages 69 to 71.

Tk:	OFF	NORM	AUTO	LIN
Tk [Tab] :	01			
Tk [Auto] :	Stop / Start			
Temp. :	0181,7 °C			15
C. :	0,210			
Ⓟ	↑	↓	↙	



twice briefly

Press button **E** once briefly to return to the start window.

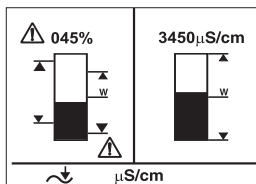

once briefly

Disabling temperature compensation

The split-screen start window shows which GESTRA bus devices can be indicated:

- High level limiter NRS 1-41
- Low level limiter NRS 1-40
- Level switch NRS 2-40
- Level controller NRR 2-40
- Conductivity controller LRR 1-40

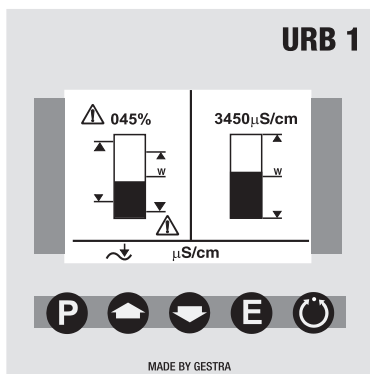

Press button 4 times briefly.

Some industrial applications may require disabling the temperature compensation. In this mode all conductivity measurements indicated by the URB 1 are **absolut** readings of the current conductivity.

In our example we start from the default factory setting “TK:LIN”.

Tk:	OFF	NORM	AUTO	<u>LN</u>
Tk [Lin]	: 2,1 % / °C			
Tk [Auto]	: <u>Stop</u> / Start			
Temp.	: 019,7 °C			
C.	: 0,210			

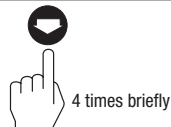

Press button twice briefly to activate the line editing mode.

flashing

<u>Tk</u> :	OFF	NORM	AUTO	<u>LN</u>
Tk [Lin]	: 2,1 % / °C			
Tk [Auto]	: <u>Stop</u> / Start			
Temp.	: 019,7 °C			
C.	: 0,210			



Commissioning – continued –

Disabling automatic (AUTO) temperature compensation – continued –

Press button **◀** 3 times briefly to select the “OFF”.

flashing

Tk:	OFF	NORM	AUTO	LIN
Tk [Lin]	: 2,1	% / °C		
Tk [Auto]	: Stop / Start			
Temp.	: 019,7 °C			
C.	: 0,210			
Ⓟ	↑	↓	↵	

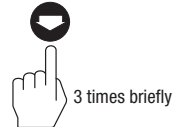

Press button **E** once briefly to accept and save the configuration.

The temperature compensation is now deactivated.

Tk:	OFF	NORM	AUTO	LIN
Tk [Lin]	: 2,1	% / °C		
Tk [Auto]	: Stop / Start			
Temp.	: 025,0 °C			
C.	: 0,210			
Ⓟ	↑	↓	↵	



Press button **E** once briefly to return to the start window.

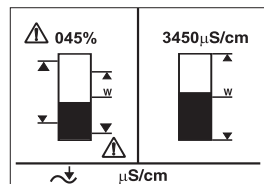

Operation

Manual operation of an external control valve

The split-screen start window shows which GESTRA bus devices can be indicated:

- High level limiter NRS 1-41
- Low level limiter NRS 1-40
- Level switch NRS 2-40
- Level controller NRR 2-40
- Conductivity controller LRR 1-40

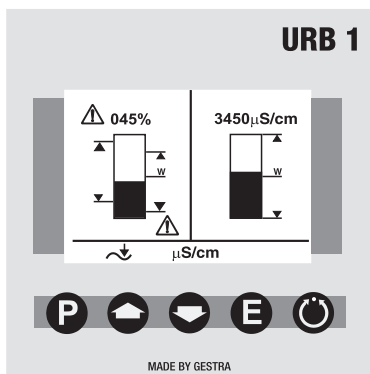

Press button  briefly to enter the display window of the level controller NRR 2-40.

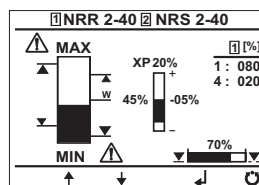

Press button  briefly to activate the manual mode.

Use buttons  and  in this mode to open and close manually an external control valve.

Press button  a second time to disable the manual mode and to move the control valve back into the position dictated by the controller NRR 2-40.

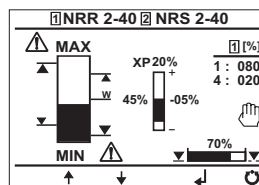

Stand-by operation with the steam boiler disconnected

The split-screen start window shows which GESTRA bus devices can be indicated:

- High level limiter NRS 1-41
- Low level limiter NRS 1-40
- Level switch NRS 2-40
- Level controller NRR 2-40
- Conductivity controller LRR 1-40

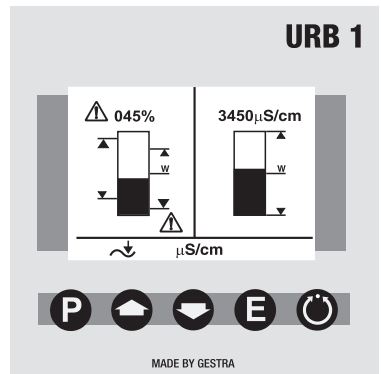

Use an **external switch** to enable the stand-by mode of the conductivity control.

After switching off the burner of the steam boiler you can deactivate the control of the continuous and intermittent blowdown valves in order to avoid loss of boiler water (stand-by operation).

After returning to normal operation the continuous blow-down valve moves into the control position and an intermittent blowdown pulse is given (if activated).

Please observe the wiring diagram shown in the installation & operating manual of the LRR 1-40.

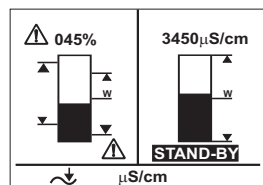

System Malfunctions

Systematic malfunction analysis

The sources of malfunctions occurring in CAN bus systems operating with several bus-based stations must be analysed systematically since faulty components or incorrect settings can give rise to negative interactions with intact bus devices in the CAN bus system. These unwanted interactions can cause error messages in fully functional bus devices, which will make fault detection even more difficult.

We recommend the following systematic fault finding procedure:

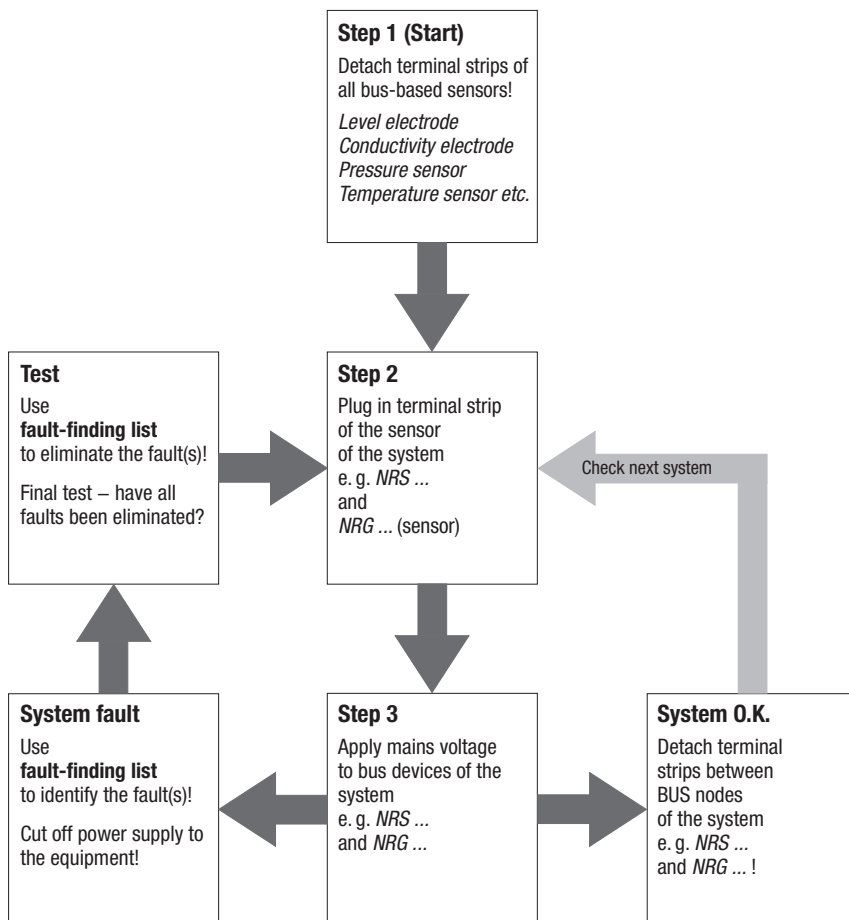

System malfunctions – continued –

Fault finding list for troubleshooting

The data communication in the CAN bus line is disrupted.

Make sure that the CAN bus line has been wired according to the wiring diagram.

Make sure that the CAN bus is not interrupted due to conductor breakage.

Make sure the controllers and electrodes feature the correct node IDs.

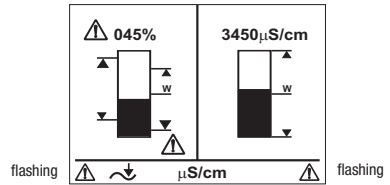

The thermal fuse of one of the level electrodes has been triggered.

Make sure that the level electrode has been mounted as specified in the installation manual.

Check whether external influences have caused built-up of heat in the electrode casing.

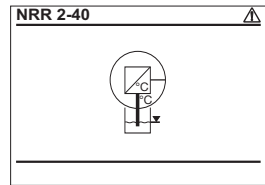

5 times briefly

The thermal fuse of the conductivity electrode has been triggered.

Make sure that the conductivity electrode has been mounted as specified in the installation manual.

Check whether external influences have caused built-up of heat in the electrode casing.

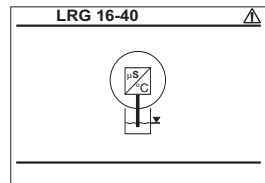

5 times briefly

The conductivity electrode is defective.

The temperature sensor of the conductivity electrode is either short circuited or interrupted.

Replace conductivity electrode LRG 16-40/-41.

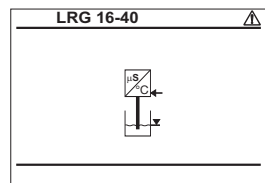

5 times briefly

System malfunctions – continued –

Fault finding list for troubleshooting – continued –

The conductivity electrode is defective.

The internal connecting cables of the conductivity electrode are short circuited or interrupted.

Replace conductivity electrode LRG 16-40/-41.

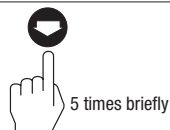
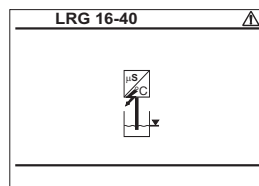

The CAN bus communication of a controller is disrupted.

Make sure that the controller and the level or conductivity electrode have been wired as specified in the wiring diagram.

In our example there is a disruption in the CAN bus communication of the low-level electrode 2 type NRG 16-40.

The screenshot shows a table of CAN bus communication parameters. A 'P' icon in a circle is visible in the bottom left corner of the table area, and a left-pointing arrow is in the bottom right corner.

NRS 1-40 ID:	001	S 2
NRS 1-41 ID:	006	
NRS 1-42 ID:	OFF	
NRS 2-40 ID:	039	
NRR 2-40 ID:	040	
LRR 1-40 ID:	050	

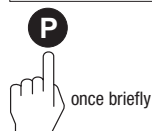

The CAN bus communication of a controller is disrupted.

Make sure that the controller and the level or conductivity electrode have been wired as specified in the wiring diagram.

In our example there is a disruption in the CAN bus communication of the controller 1 type NRS 1-40.

The screenshot shows a table of CAN bus communication parameters. A 'P' icon in a circle is visible in the bottom left corner of the table area, and a left-pointing arrow is in the bottom right corner.

NRS 1-40 ID:	001	St
NRS 1-41 ID:	006	
NRS 1-42 ID:	OFF	
NRS 2-40 ID:	039	
NRR 2-40 ID:	040	
LRR 1-40 ID:	050	

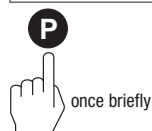

If faults occur that are not listed above or cannot be corrected, please contact our service centre or authorized agency in your country.

Annex

Note on the Declaration of Conformity / Declaration by the Manufacturer CE

For details on the conformity of our equipment according to the European Directives see our Declaration of Conformity or our Declaration of Manufacturer.

The current Declaration of Conformity / Declaration of Manufacturer are available in the Internet under www.gestra.de/documents or can be requested from us.



Agencies all over the world: www.gestra.de

GESTRA AG

Münchener Straße 77

28215 Bremen

Germany

Telefon +49 421 3503-0

Telefax +49 421 3503-393

E-mail info@de.gestra.com

Web www.gestra.de